

MULTIPLE CD PLAYER
 1060CD/1070CD
 DP-R6090/R7090
 D-R350
 SERVICE MANUAL

KENWOOD

© 1997-7 /B51-5326-00 (K/K) 3654

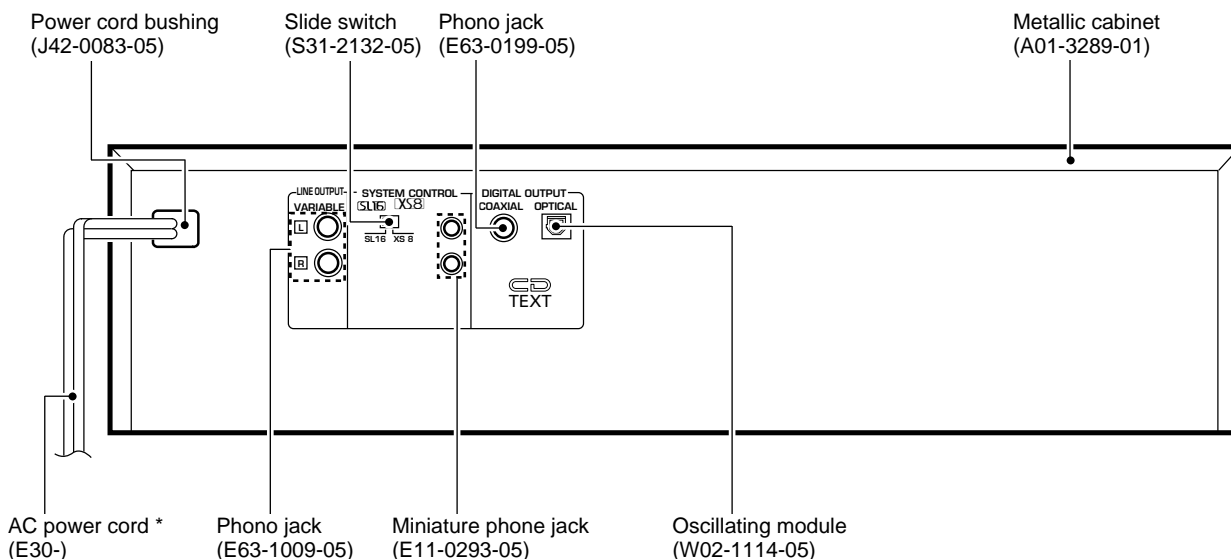
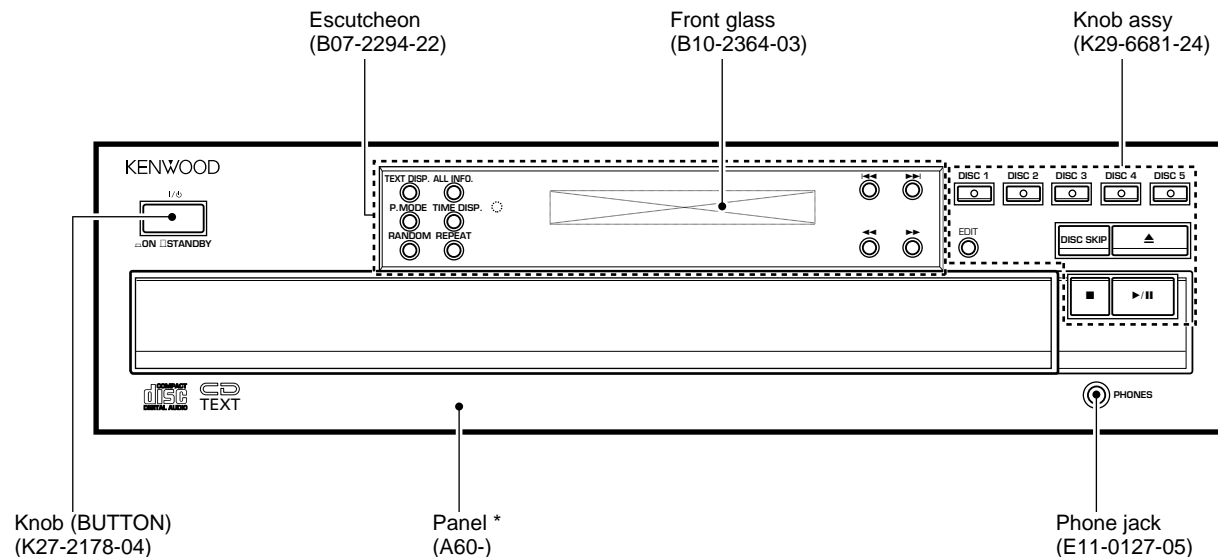

In compliance with Federal Regulations, following are reproductions of labels on, or inside the product relating to laser product safety.

KENWOOD-Corp. certifies this equipment conforms to DHHS Regulations No. 21 CFR 1040. 10, Chapter 1, Subchapter J.

**DANGER : Laser radiation when open and interlock defeated.
 AVOID DIRECT EXPOSURE TO BEAM.**

Illust is DP-R6090.

* Refer to parts list on page 21.



CONTENTS / ACCESSORIES / CAUTION

Contents

CONTENTS / ACCESSORIES / CAUTION	2	SCHEMATIC DIAGRAM	9
EXTERNAL VIEW	3	EXPLODED VIEW	18
ADJUSTMENT	4	PARTS LIST	21
PC BOARD	5	SPECIFICATIONS	27

Accessories

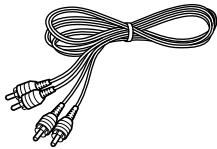
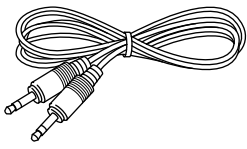
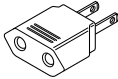
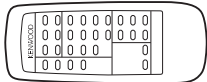
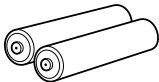
<p>Audio cord (1) (E30-0505-05)</p> 	<p>System control cord (1) (E30-2733-05)</p> 	<p>AC plug adapter (1) (E03-0115-05) DP-R6090/R7090/D-R300 : M type only</p> 
<p>Remote control unit (1) (A70-1134-05) : RC-P0601 1060CD/1070CD/DP-R6090/R7090</p> 	<p>Batteries (R6/AA) (2) DP-R4090 only</p> 	

Battery cover: (A09-0356-08)

Caution

Note related to transportation and movement

Before transporting or moving this unit, carry out the following operations.

1. Turn the power ON but do not load a disc.
2. Wait a few seconds and verify that the display shown appears.
Wait further a few seconds.
3. Turn the power OFF.



1060CD/1070CD/DP-R6090/R7090/D-R350

EXTERNAL VIEW

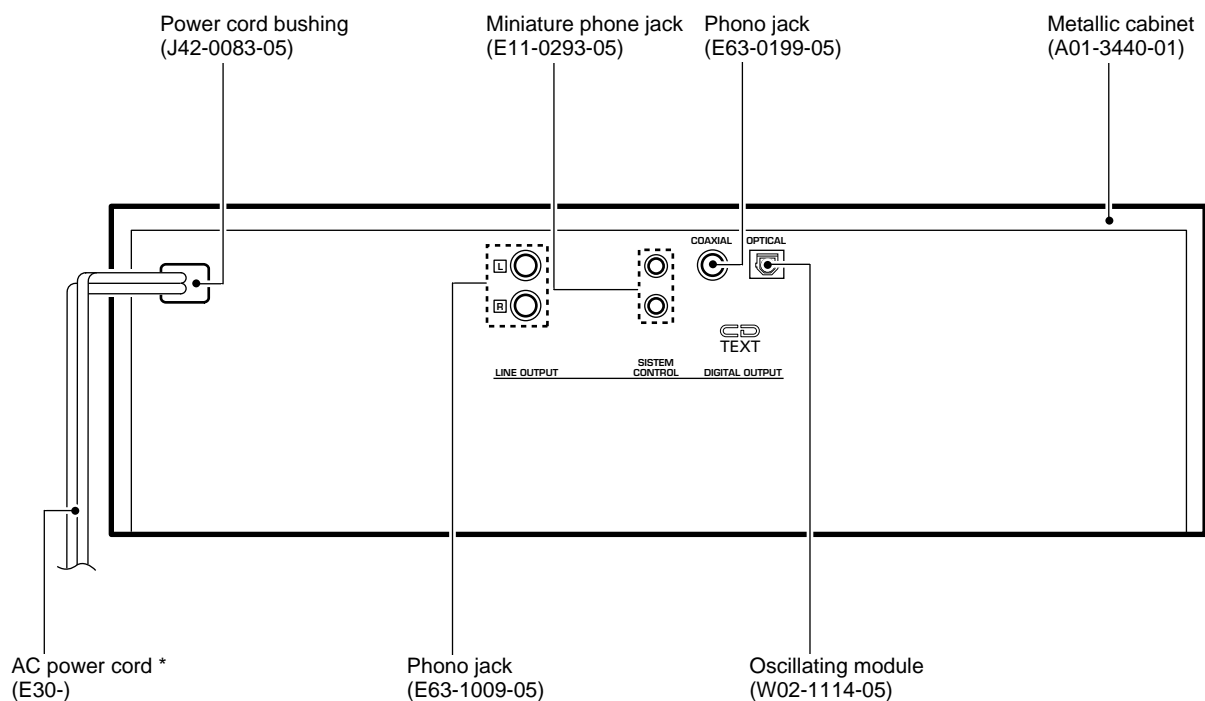
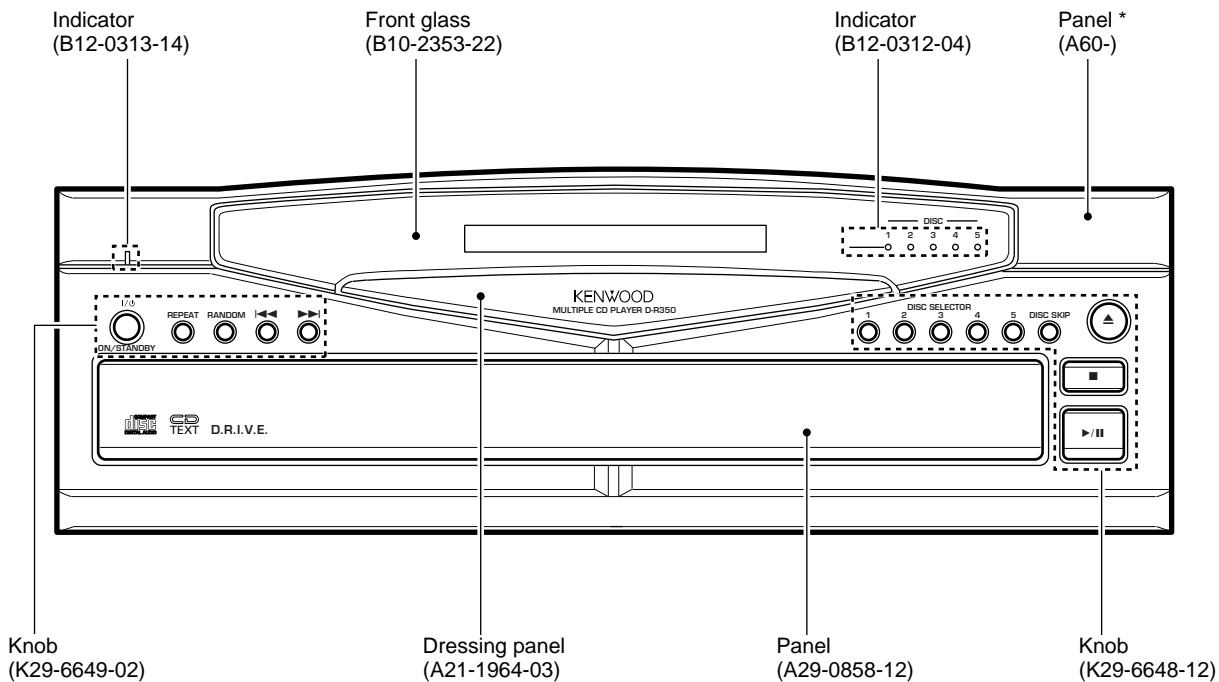

Illust is D-R350.

* Refer to parts list on page 21.

ADJUSTMENT

No.	ITEM	INPUT SETTINGS	OUTPUT SETTINGS	PLAYER SETTINGS	ALIGNMENT POINTS	ALIGN FOR	FIG.
Step 1~4 are in TEST MODE							
1	LASER POWER	—	Apply the sensor section of optical power meter on the pickup lens.	While pressing the RANDOM key, turn the AC ON. (Test mode) Press the PLAY/PAUSE key, then confirm that the display is "03".	—	On the power from 0.08 to 0.15 mW, when the diffraction grating is correctly aligned with the RF level of 1.0 Vp-p or more.	(a)
2	TRACKING ERROR BALANCE	Test disc Type 4	Connect an oscilloscope as follows. CH1 : RF (CN2 pin 1) CH2 : TE (CN2 pin 6)	Press the PLAY/PAUSE key, then confirm that the display is "03".	TE BALANCE VR2	Symmetry between upper and lower patterns	
3	FOCUS ERROR BALANCE	Test disc Type 4	Connect an oscilloscope as follows. CH1 : RF (CN2 pin 1) CH2 : FE (CN2 pin 2)	Press the PLAY/PAUSE key, then confirm that the display is "05".	FE BALANCE VR1	Optimum eye pattern	
4	TRACKING GAIN	Test disc Type 4 Apply signal of 1.2 kHz, 50mVrms to CN2 pin 5-6.	Connect a LPF to CN2 pin 5-6 to which you connect an oscilloscope or AC voltmeters.	Press the PLAY/PAUSE key, then confirm that the display is "05".	TRACKING GAIN VR3	Two VTVMs should read the same value.	(e)

Note:

Type 4 disc : SONY YEDS-18 Test Disc or equivalent.

LPF: Around 47 kΩ+ 390 pF or so.

(a) Laser power

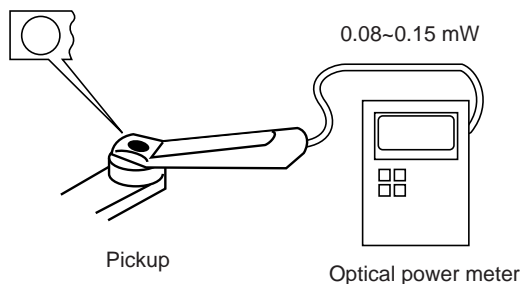

(e) Tracking gain

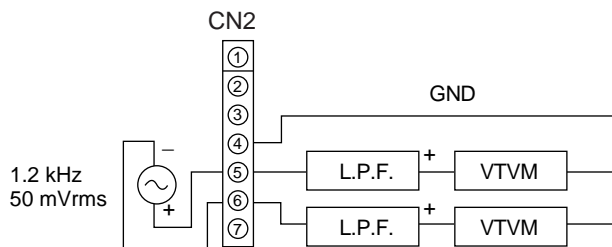

PC BOARD(Component side view)

CD player unit (X32-333x-xx)

0-10 : D-R350
 0-11 : 1060CD
 0-12 : 1070CD
 0-21 : D-R350

KP
 KP
 TE
 KP
 YMI

0-22 : 1060CD Y
 DP-R6090 M
 X32 D/8

0-23 : 1070CD Y

X32-3330-XX A/8

X32 F/8

X32 G/8

X32 E/8

AC110-120V

AC220-240V

AC110-120V

AC220-240V

X32 B/8

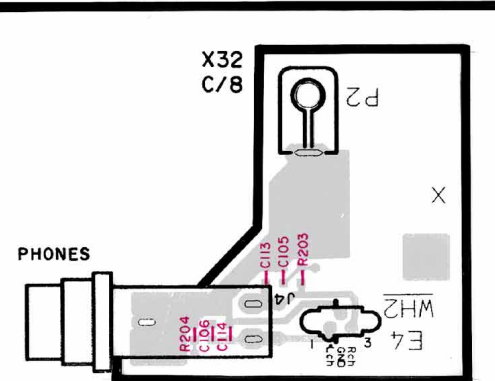
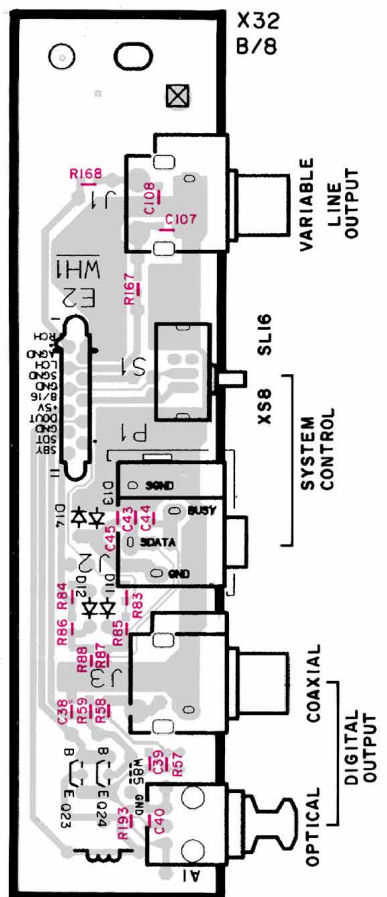
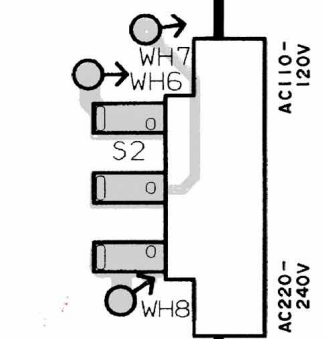
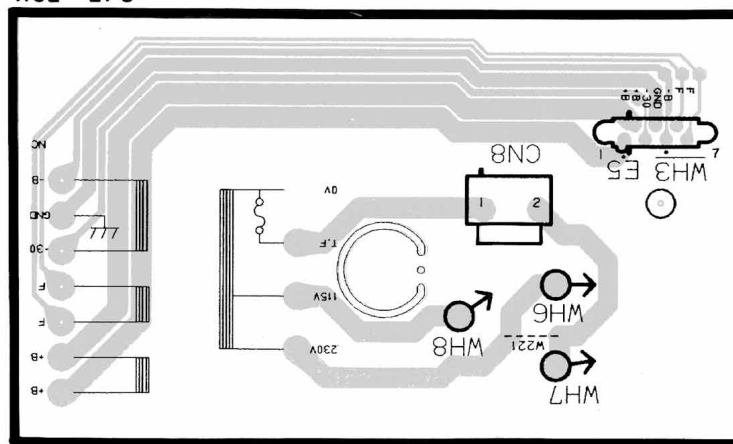
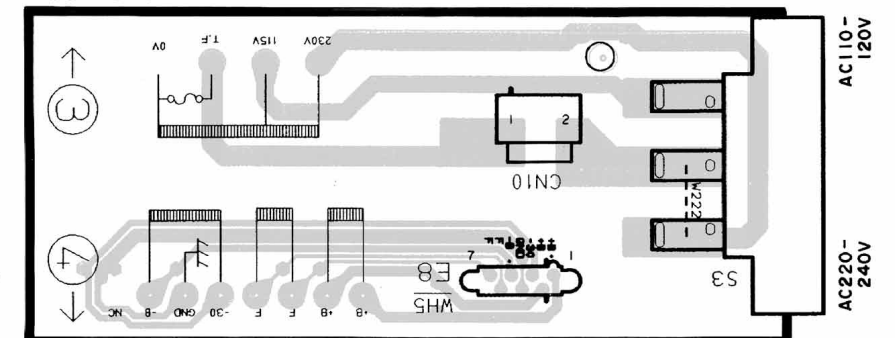
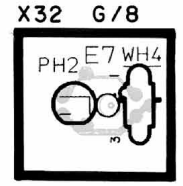
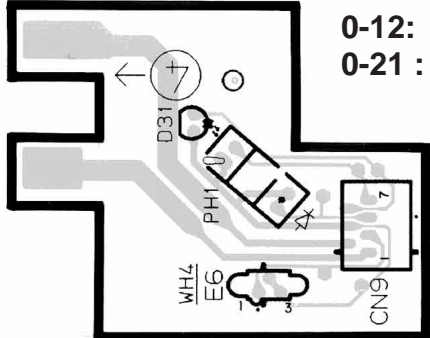
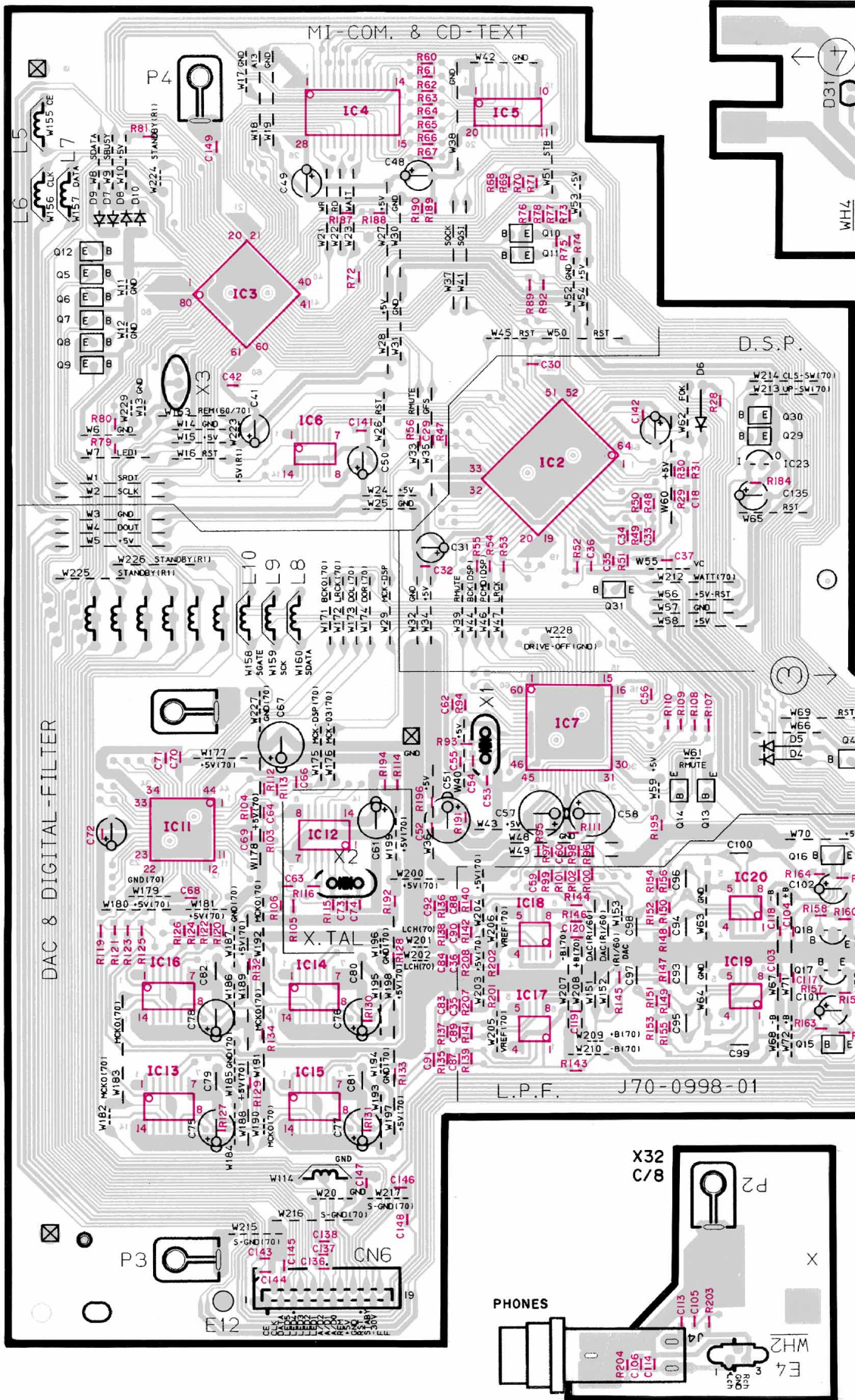

PC BOARD(Component side view)

Display unit (X25-590x-xx) 0-10 : 1070CD
 DP-R7090
 0-11 : 1060CD
 DP-R6090

X25-5900-10 A/3

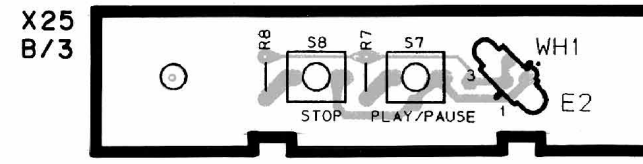
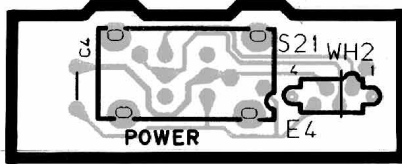
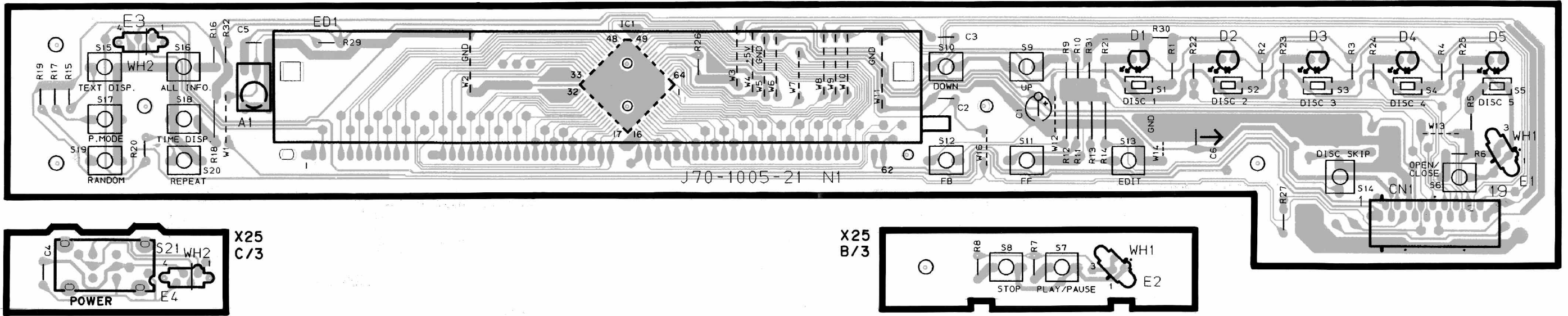

Display unit (X25-5910-10) D-R350

X25-5910-10 A/3

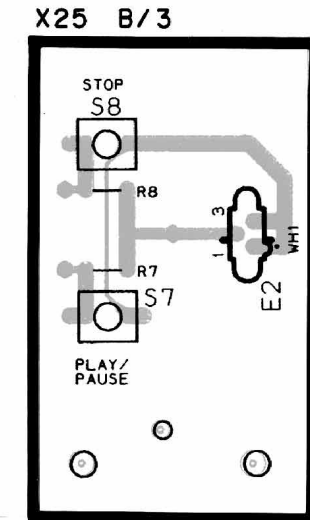
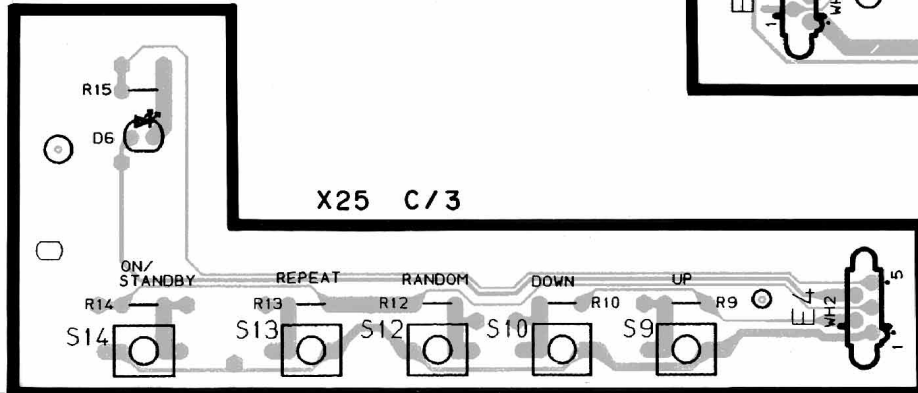
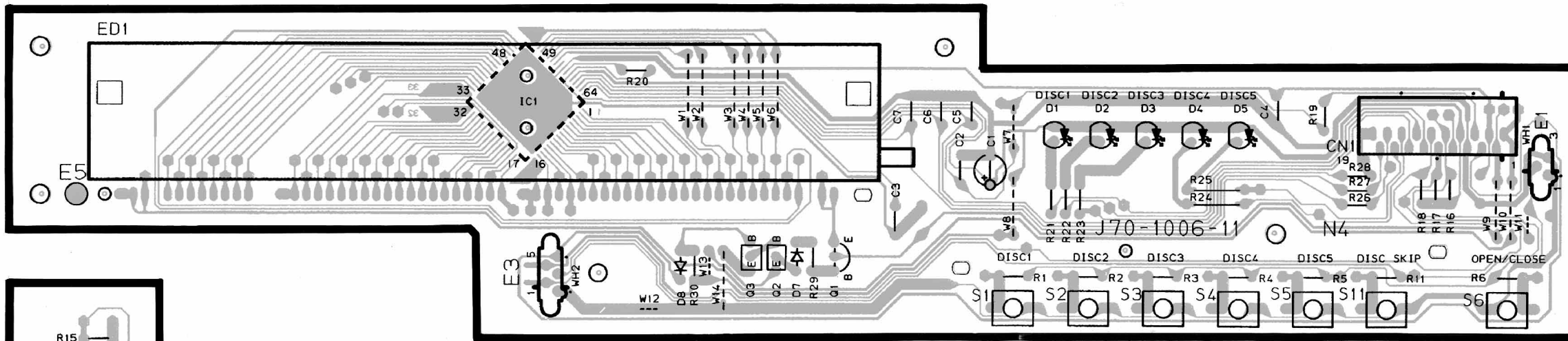

MECHA. ASS'Y (CDM-25)
(X92-1930-10/X92-1960-71)

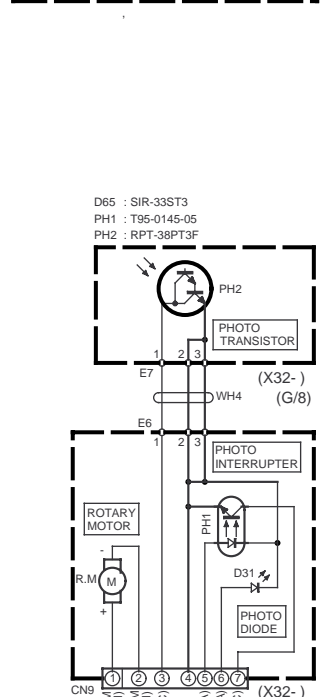
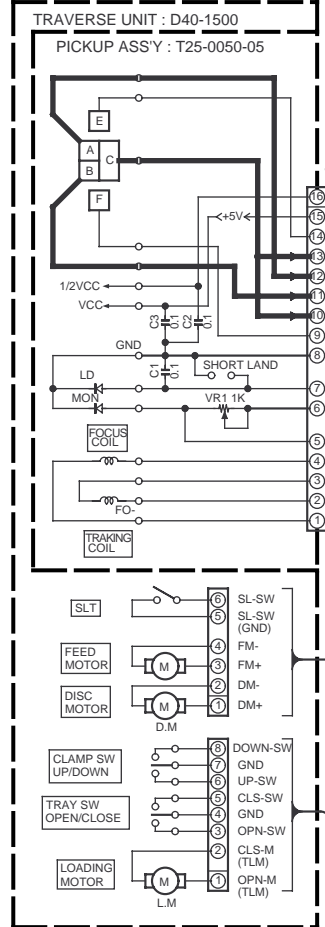

CD PLAYER UNIT
(X32-3330-XX) (A/8)

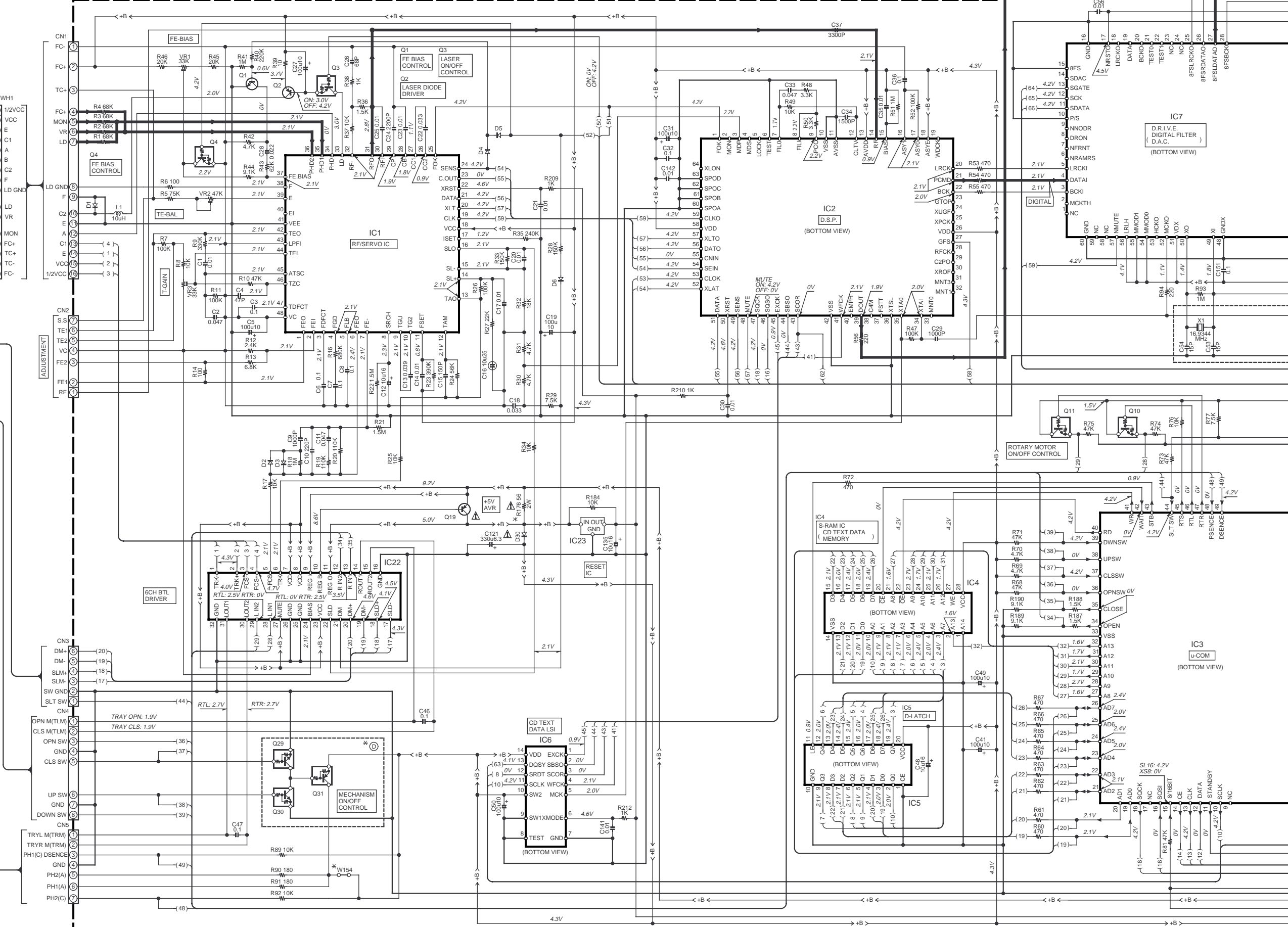

1
2
3
4
5
6
7

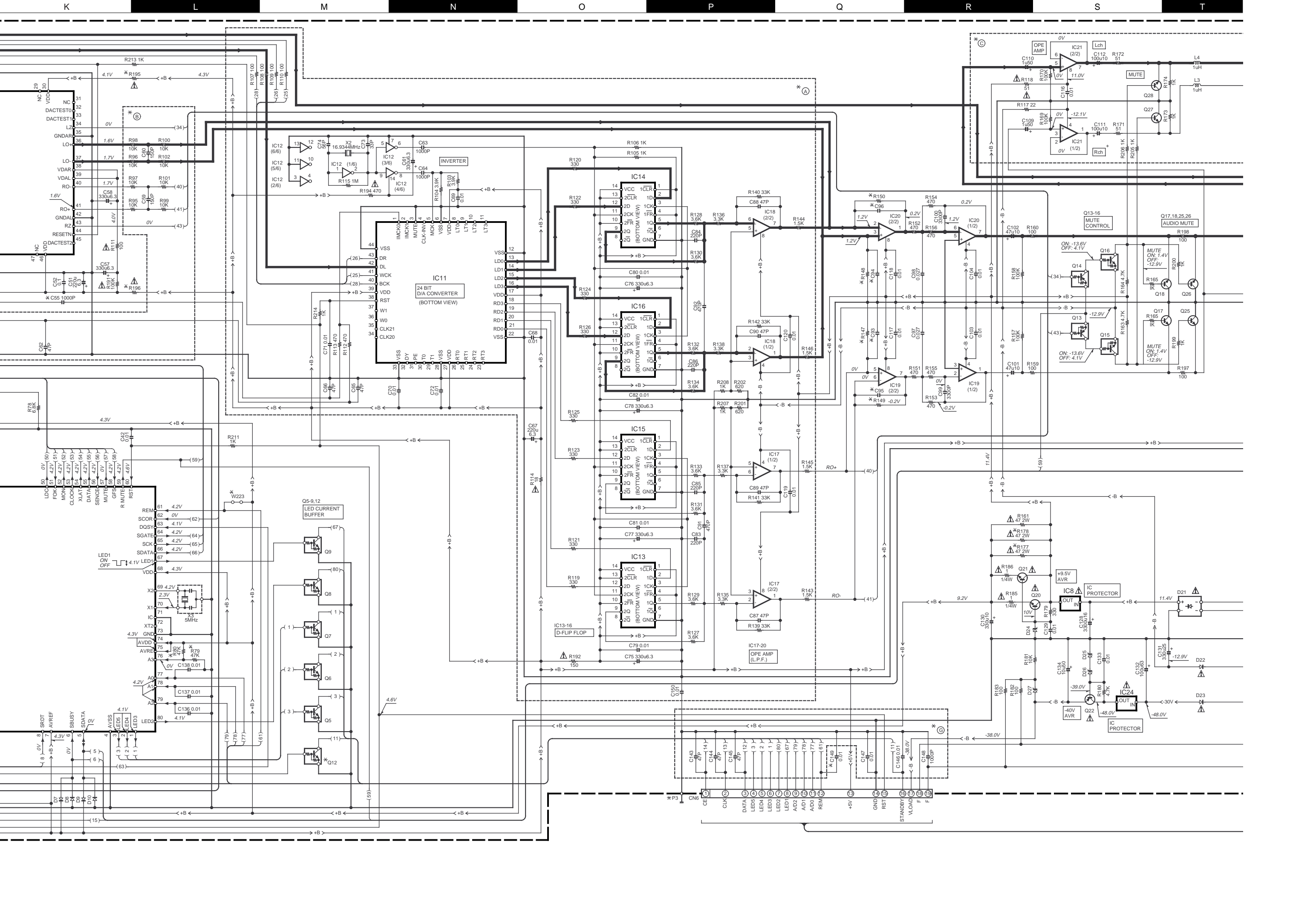

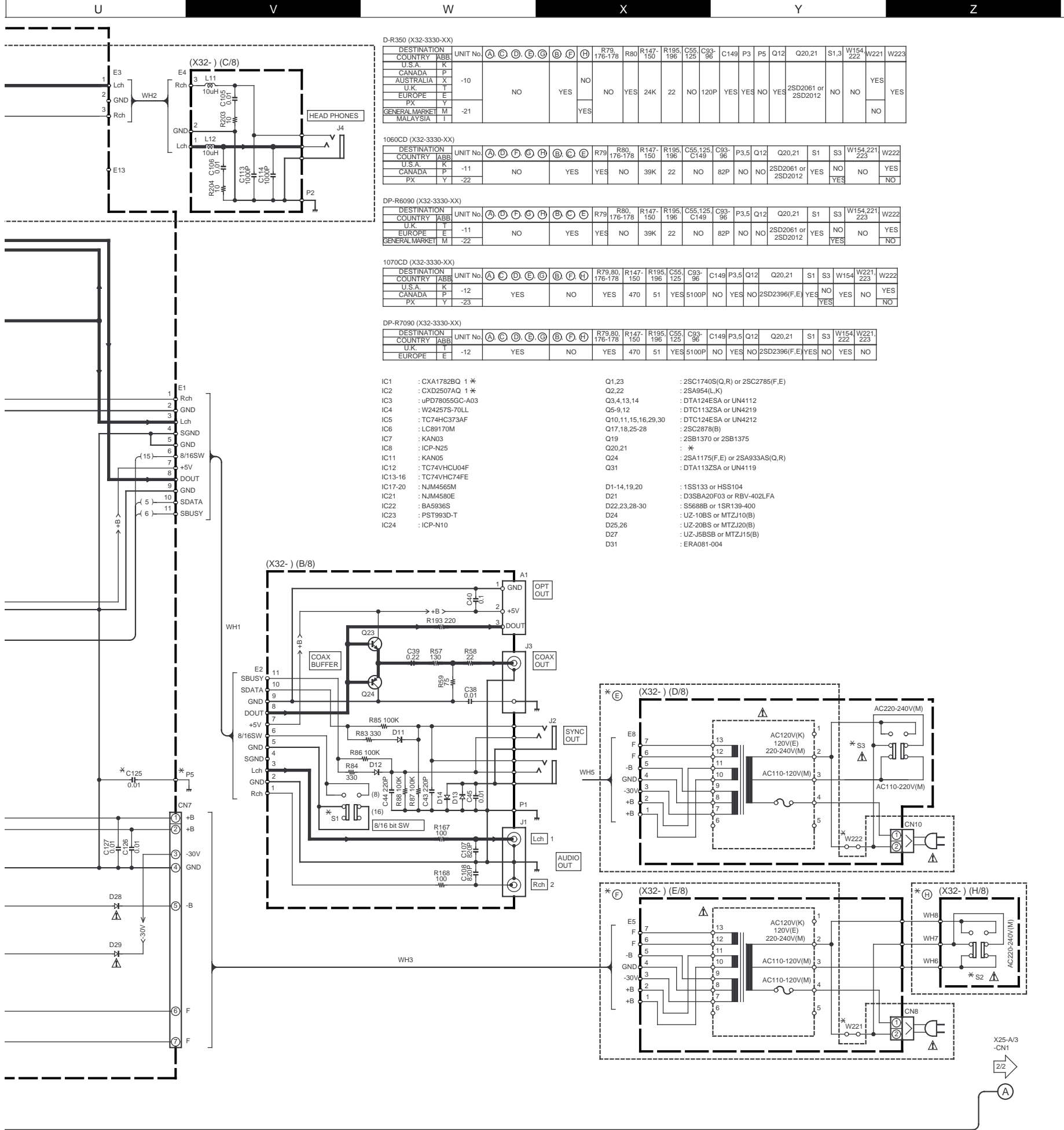

D-R350 (X32-3330-XX)

DESTINATION	COUNTRY	ABB	UNIT No	A	C	D	E	G	H	F	R79, 176-178	R80, 176-178	R147-150	R195, 196	C55, 125	C93-96	C149	P3,5	Q12	Q20,21	S1,3	W154, 221, 222	W221	W223	
U.S.A.	K		-10							NO	NO	YES	24K	22	NO	120P	YES	YES	NO	YES	2SD2061 or 2SD2012	NO	NO	YES	YES
CANADA	P																								
AUSTRALIA	X																								
U.K.	T																								
EUROPE	E									YES															
FX	Y																								
GENERAL MARKET	M		-21																						
MALAYSIA	I																								

1060CD (X32-3330-XX)

DESTINATION	COUNTRY	ABB	UNIT No	A	C	D	E	G	H	F	R79, 176-178	R80, 176-178	R147-150	R195, 196	C55, 125	C93-96	C149	P3,5	Q12	Q20,21	S1	S3	W154, 221, 223	W222	
U.S.A.	K		-11							YES	NO	NO	39K	22	NO	82P	NO	NO	NO	2SD2061 or 2SD2012	YES	NO	NO	NO	YES
CANADA	P																								
FX	Y		-22																						

DP-R6090 (X32-3330-XX)

DESTINATION	COUNTRY	ABB	UNIT No	A	C	D	E	G	H	F	R79, 176-178	R80, 176-178	R147-150	R195, 196	C55, 125	C93-96	C149	P3,5	Q12	Q20,21	S1	S3	W154, 221, 223	W222	
U.S.A.	K		-11							YES	NO	NO	39K	22	NO	82P	NO	NO	NO	2SD2061 or 2SD2012	YES	NO	NO	NO	YES
CANADA	P																								
FX	Y		-22																						

1070CD (X32-3330-XX)

DESTINATION	COUNTRY	ABB	UNIT No	A	C	D	E	G	H	F	R79, 80, 176-178	R147-150	R195, 196	C55, 125	C93-96	C149	P3,5	Q12	Q20,21	S1	S3	W154, 221, 223	W222		
U.S.A.	K		-12							YES	NO	YES	470	51	YES	5100P	NO	YES	NO	2SD2396(F,E)	YES	NO	YES	NO	YES
CANADA	P																								
FX	Y		-23																						

DP-R7090 (X32-3330-XX)

DESTINATION	COUNTRY	ABB	UNIT No	A	C	D	E	G	H	F	R79, 80, 176-178	R147-150	R195, 196	C55, 125	C93-96	C149	P3,5	Q12	Q20,21	S1	S3	W154, 221, 223	W222		
U.K.	T		-12							YES	NO	YES	470	51	YES	5100P	NO	YES	NO	2SD2396(F,E)	YES	NO	YES	NO	YES
EUROPE	E																								

- IC1 : CXA1782BQ 1 *
- IC2 : CXD2507AQ 1 *
- IC3 : uPD78055GC-A03
- IC4 : W24257S-70LL
- IC5 : TC74HC373AF
- IC6 : LC89170M
- IC7 : KAN03
- IC8 : ICP-N25
- IC11 : KAN05
- IC12 : TC74VHC04F
- IC13-16 : TC74VHC74FE
- IC17-20 : NJM4565M
- IC21 : NJM4580E
- IC22 : BA5936S
- IC23 : PST993D-T
- IC24 : ICP-N10
- Q1,23 : 2SC1740S(Q,R) or 2SC2785(F,E)
- Q2,22 : 2SA954(L,K)
- Q3,4,13,14 : DTA124ESA or UN4112
- Q5-9,12 : DTC113ZSA or UN4219
- Q10,11,15,16,29,30 : DTC124ESA or UN4212
- Q17,18,25-28 : 2SC2878(B)
- Q19 : 2SB1370 or 2SB1375
- Q20,21 : *
- Q24 : 2SA1175(F,E) or 2SA933AS(Q,R)
- Q31 : DTA113ZSA or UN4119
- D1-14,19,20 : 1SS133 or HSS104
- D21 : D3SBA20F03 or RBV-402LFA
- D22,23,28-30 : S5688B or 1SR139-400
- D24 : UZ-10BS or MTZJ10(B)
- D25,26 : UZ-20BS or MTZJ20(B)
- D27 : UZ-J5BSB or MTZJ15(B)
- D31 : ERA081-004

CAUTION: For continued safety, replace safety critical components only with manufacturer's recommended parts (refer to parts list). ⚠ indicates safety critical components. For continued protection against risk of fire, replace only with same type and rating fuse(s). To reduce the risk of electric shock, leakage-current or resistance measurements shall be carried out (exposed parts are acceptably insulated from the supply circuit) before the appliance is returned to the customer.

The DC voltage is an actual reading measured with a high impedance type voltmeter. The measurement value may vary depending on the measuring instruments used or on the product. Refer to the voltage during PLAY unless otherwise specified; The value shown in () is the voltage measured at the moment of STOP.

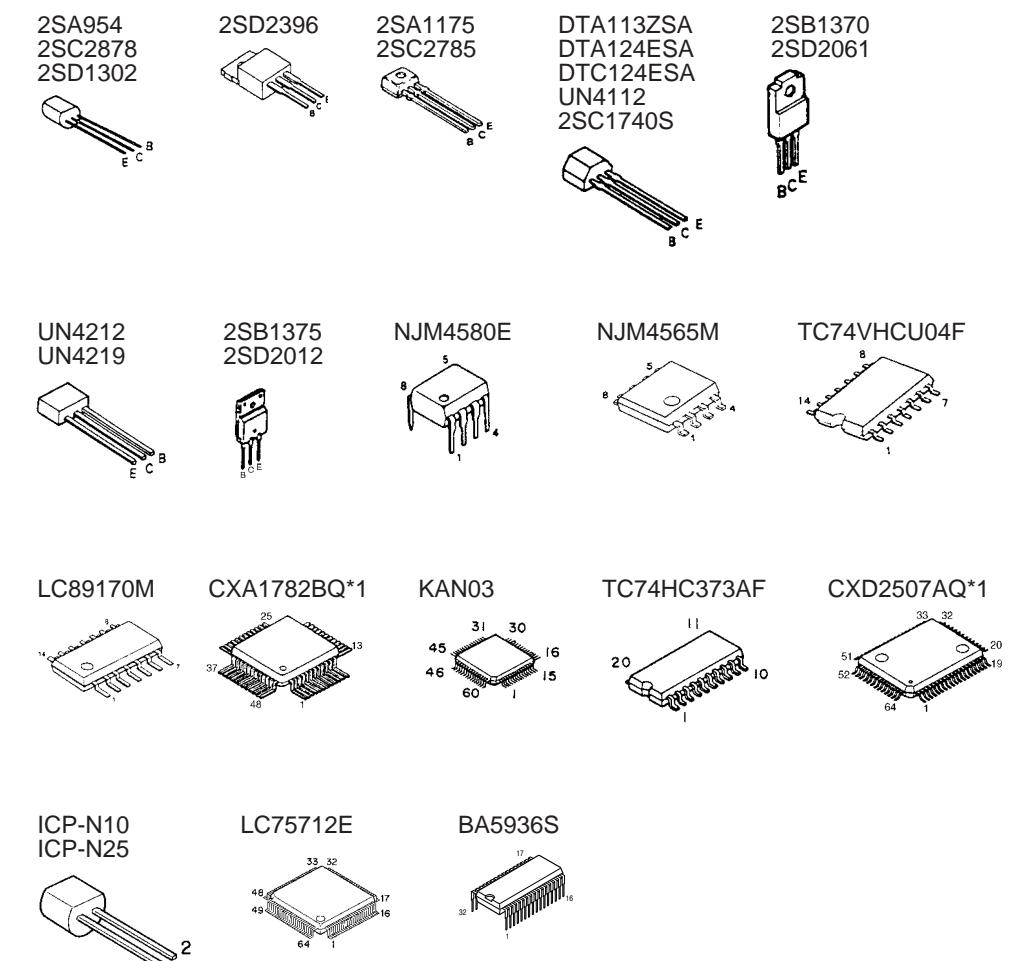

1060CD/DP-R6090/1070CD/DP-R7090/D-R350(K) (1/2)

1060CD/1070CD/DP-R6090/R7090/D-R350

Y22-7040-10

KENWOOD

DISPLAY VUNIT (X25-5900-XX) (A/3) -10 : 1070CD/DP-R7090 -11 : 1060CD/DP-R6090

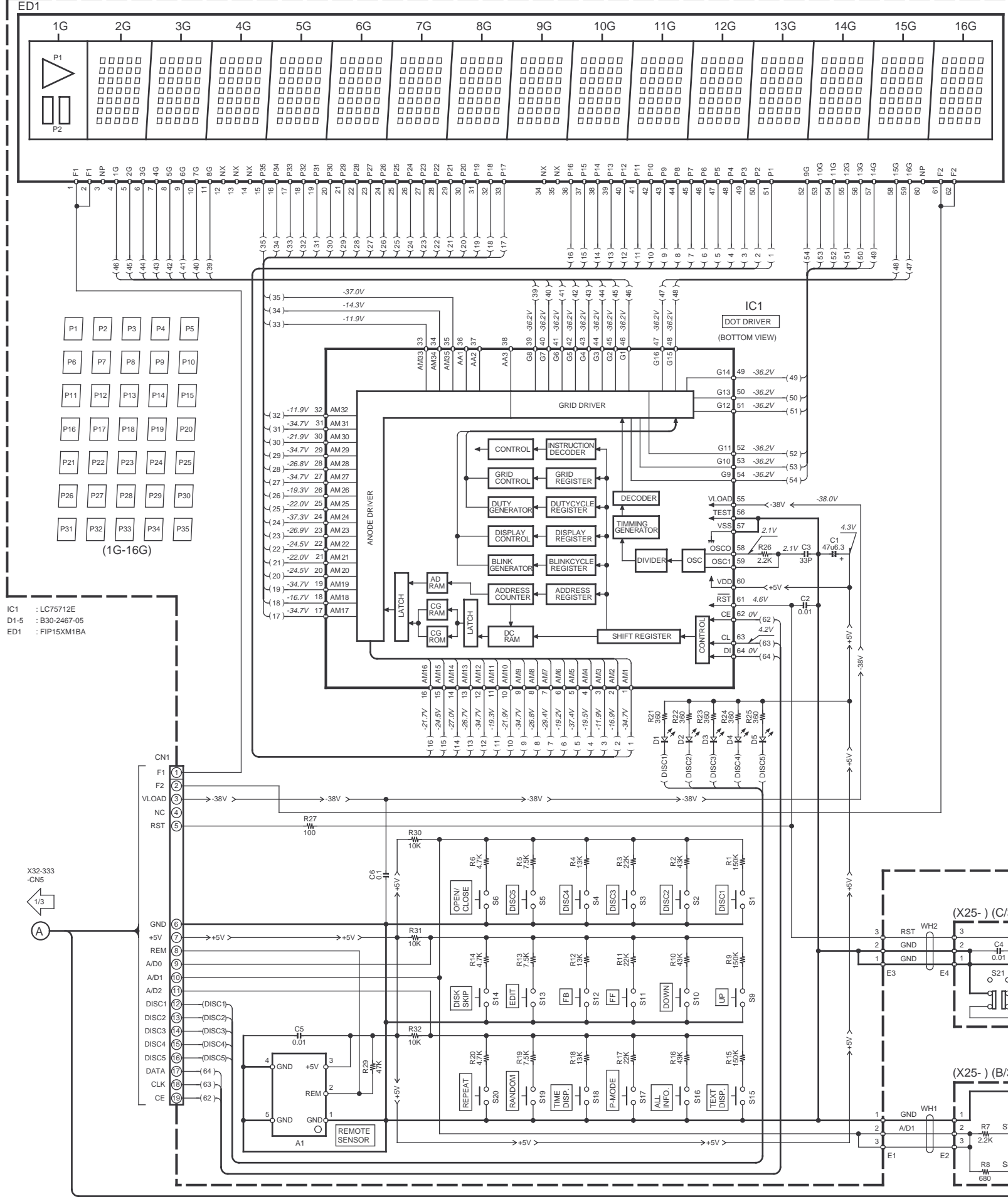

IC1 : LC75712E
 D1-5 : B30-2467-05
 ED1 : FIP15XM1BA

DISPLAY UNIT (X25-5910-10) (A/3) D-R350

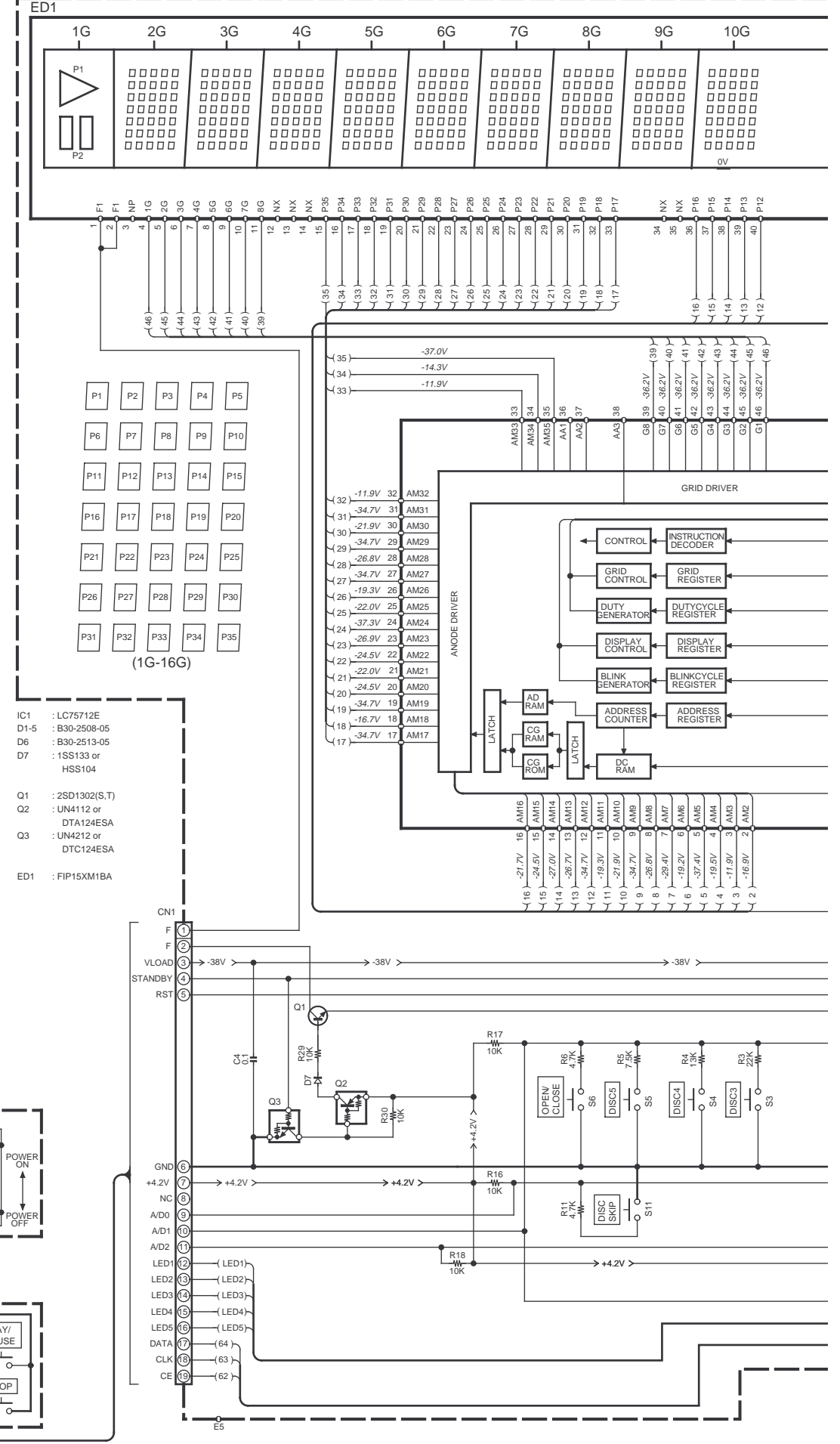

IC1 : LC75712E
 D1-5 : B30-2508-05
 D6 : B30-2513-05
 D7 : 1SS133 or HSS104
 Q1 : 2SD1302(S,T)
 Q2 : UN4112 or DTA124ESA
 Q3 : UN4212 or DTC124ESA
 ED1 : FIP15XM1BA

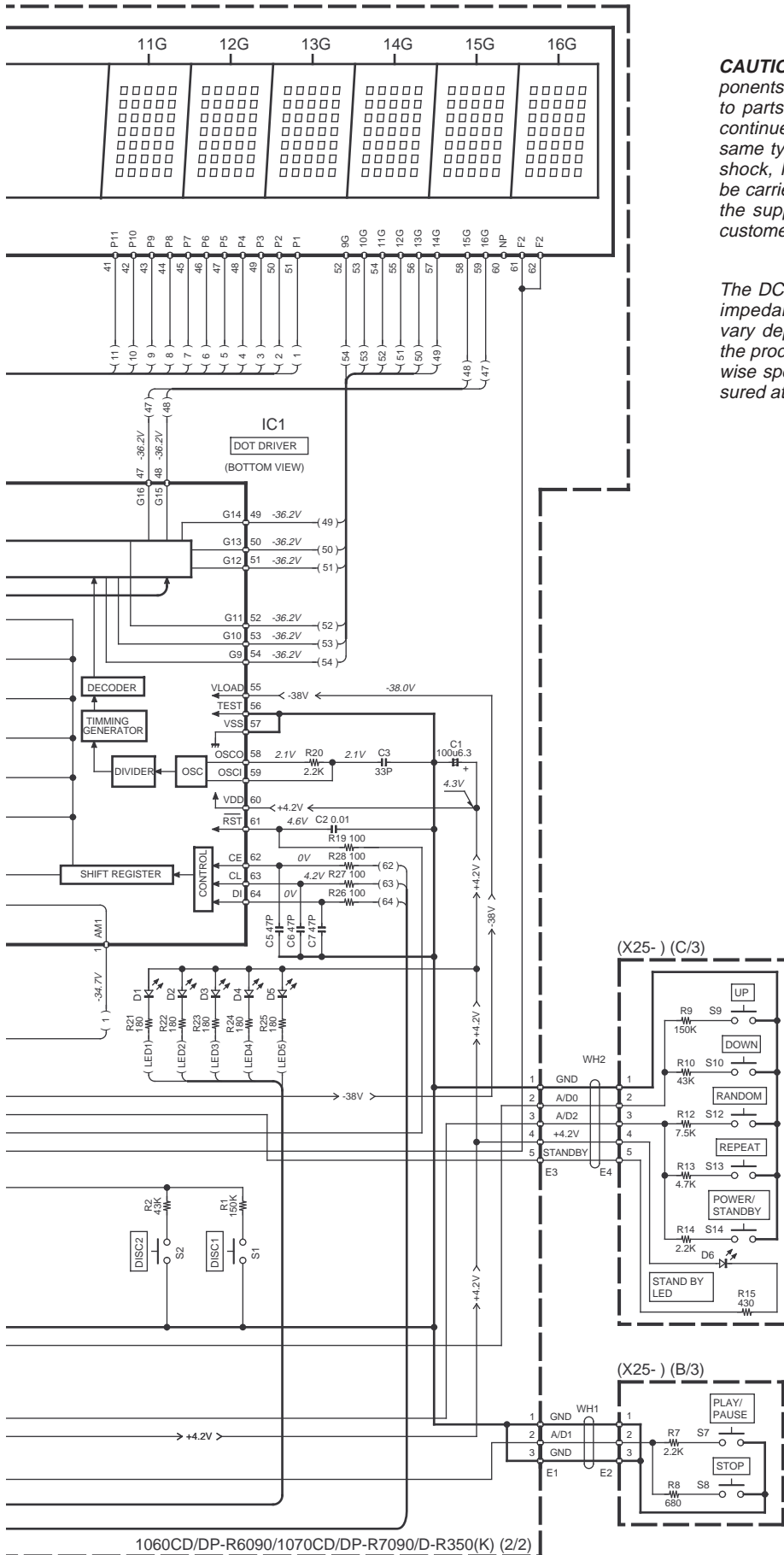

CAUTION: For continued safety, replace safety critical components only with manufacturer's recommended parts (refer to parts list). Δ indicates safety critical components. For continued protection against risk of fire, replace only with same type and rating fuse(s). To reduce the risk of electric shock, leakage-current or resistance measurements shall be carried out (exposed parts are acceptably insulated from the supply circuit) before the appliance is returned to the customer.

The DC voltage is an actual reading measured with a high impedance type voltmeter. The measurement value may vary depending on the measuring instruments used or on the product. Refer to the voltage during PLAY unless otherwise specified; The value shown in () is the voltage measured at the moment of STOP.

1060CD/DP-R6090/1070CD/DP-R7090/D-R350(K) (2/2)

1060CD/1070CD/DP-R6090/R7090/D-R350

Y22-7040-10

KENWOOD

EXPLODED VIEW(UNIT)

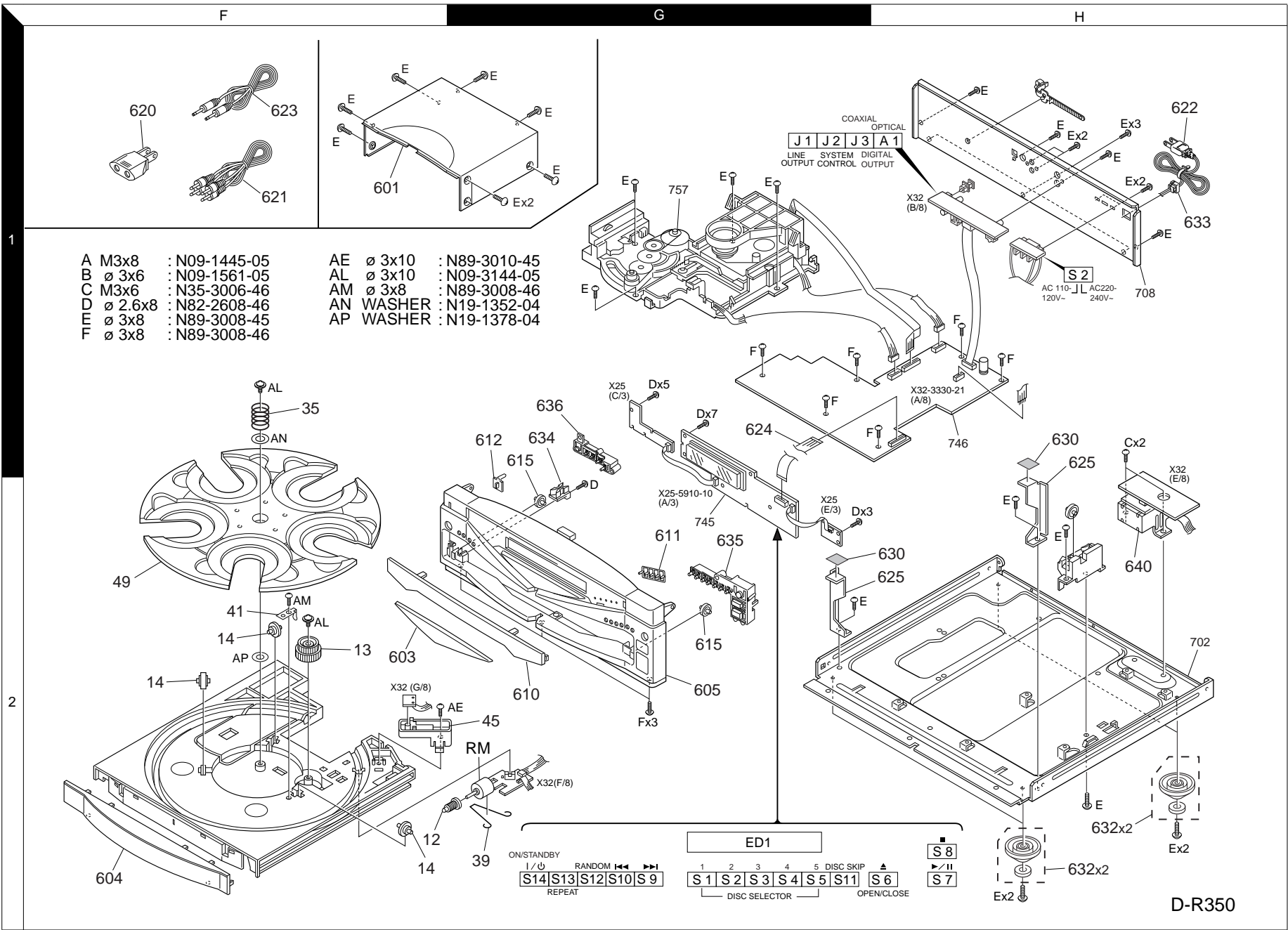

- | | | | | | |
|---|---------|---------------|----|--------|---------------|
| A | M3x8 | : N09-1445-05 | AE | ∅ 3x10 | : N89-3010-45 |
| B | ∅ 3x6 | : N09-1561-05 | AL | ∅ 3x10 | : N09-3144-05 |
| C | M3x6 | : N35-3006-46 | AM | ∅ 3x8 | : N89-3008-46 |
| D | ∅ 2.6x8 | : N82-2608-46 | AN | WASHER | : N19-1352-04 |
| E | ∅ 3x8 | : N89-3008-45 | AP | WASHER | : N19-1378-04 |
| F | ∅ 3x8 | : N89-3008-46 | | | |

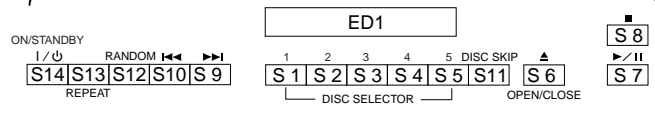

D-R350

* New Parts
 Parts without **Parts No.** are not supplied.
 Les articles non mentionnés dans le **Parts No.** ne sont pas fournis.
 Teile ohne **Parts No.** werden nicht geliefert.

①

Ref. No	Add-ress	New Parts	Parts No.	Description	Desti-nation	Re-marks
1060CD/1070CD/DP-R6090/DP-R7090						
601	1D	*	A01-3289-01	METALLIC CABINET		
603	1D	*	A60-1149-01	PANEL	K7P7Y7	
603	1D	*	A60-1150-01	PANEL	T7E7	
603	1D	*	A60-1151-01	PANEL	K6P6Y6	
603	1D	*	A60-1152-01	PANEL	M6T6E6	
604	1C	*	A70-1134-05	REMOTE CONTROLLER(RC-P0601)		
605	1C		A09-0356-08	BATTERY COVER		
610	2D		B07-2294-22	ESCUTCHEON		
611	2D	*	B10-2364-03	FRONT GLASS		
612	2D		B11-0301-03	COLOR FILTER		
-	-		B46-0197-00	QUESTIONNAIRE CARD	K6K7	
-	-		B46-0310-03	WARRANTY CARD	T6E6	
-	-		B46-0310-03	WARRANTY CARD	T7E7	
-	-		B46-0328-03	WARRANTY CARD	K6Y6	
-	-		B46-0328-03	WARRANTY CARD	K7Y7	
-	-	*	B46-0336-03	WARRANTY CARD	P6P7	
-	-		B58-0513-04	CAUTION CARD (PRESET220-240)	Y6Y7	
-	-		B58-0945-03	CAUTION CARD	T6T7	
-	-		B58-0964-13	CAUTION CARD (UL)	K6Y6	
-	-		B58-0964-13	CAUTION CARD (UL)	K7Y7	
-	-	*	B58-0965-13	CAUTION CARD (T,XtypePL)	T6T7	
-	-	*	B58-0966-13	CAUTION CARD (ELMtypePL)	M6E6E7	
-	-	*	B58-0967-03	CAUTION CARD (PtypePL)	P6P7	
-	-		B59-1104-00	SERVICE DIRECTORY	Y6Y7	
-	-	*	B60-3243-00	INSTRUCTION MANUAL(ENGLISH)	K6P6Y6	
-	-	*	B60-3243-00	INSTRUCTION MANUAL(ENGLISH)	K7P7Y7	
-	-	*	B60-3244-00	INSTRUCTION MANUAL(FRENCH)	P6P7	
-	-	*	B60-3245-00	INSTRUCTION MANUAL(ENGLISH)	M6T6T7	
-	-	*	B60-3246-00	INSTRUCTION MANUAL(FRN.GER)	E6E7	
-	-	*	B60-3247-00	INSTRUCTION MANUAL(DUTCH,ITAL)	E6E7	
-	-	*	B60-3248-00	INSTRUCTION MANUAL(SPANISH)	M6E6E7	
-	-	*	B60-3249-00	INSTRUCTION MANUAL8(CHINESE)	M6	
615	1D		D14-0357-04	ROLLER		
Δ 620	1C		E03-0115-05	AC PLUG ADAPTER	M6	
621	1C		E30-0505-05	AUDIO CORD		
Δ 622	1E		E30-2592-15	AC POWER CORD	M6E6E7	
Δ 622	1E		E30-2605-05	AC POWER CORD	Y6Y7	
Δ 622	1E		E30-2650-05	AC POWER CORD	K6P6	
Δ 622	1E		E30-2650-05	AC POWER CORD	K7P7	
Δ 622	1E		E30-2721-05	AC POWER CORD	T6T7	
623	1C		E30-2733-05	CORD WITH PLUG		
624	2E		E35-0400-05	WIRING HARNESS		
-	-		H10-7280-02	POLYSTYRENE FOAMED FIXTURE	K6P6Y6	
-	-		H10-7280-02	POLYSTYRENE FOAMED FIXTURE	K7P7Y7	
-	-		H10-7280-02	POLYSTYRENE FOAMED FIXTURE	M6E6E7	
-	-		H10-7281-02	POLYSTYRENE FOAMED FIXTURE	K6P6Y6	
-	-		H10-7281-02	POLYSTYRENE FOAMED FIXTURE	K7P7Y7	
-	-		H10-7281-02	POLYSTYRENE FOAMED FIXTURE	M6E6E7	
-	-		H10-7282-02	POLYSTYRENE FOAMED FIXTURE	T6T7	
-	-		H10-7283-02	POLYSTYRENE FOAMED FIXTURE	T6T7	
-	-		H12-2344-04	PACKING FIXTURE		
-	-		H13-0163-04	CARTON BOARD	T6T7	

L : Scandinavia K : USA P : Canada R : Mexico
 Y : PX(Far East, Hawaii) T : Europe E : Europe G : Germany
 Y : AAFES(Europe) X : Australia M : Other Areas Q : Russia

Δ indicates safety critical components.

* New Parts
 Parts without **Parts No.** are not supplied.
 Les articles non mentionnés dans le **Parts No.** ne sont pas fournis.
 Teile ohne **Parts No.** werden nicht geliefert.

②

Ref. No	Add-ress	New Parts	Parts No.	Description	Desti-nation	Re-marks
-	-		H20-0568-04	PROTECTION COVER	M6	
-	-		H21-0303-04	PROTECTION SHEET		
-	-		H25-0232-04	PROTECTION BAG (235X350X0.03)	K6P6Y6	
-	-		H25-0232-04	PROTECTION BAG (235X350X0.03)	K7P7Y7	
-	-		H25-0232-04	PROTECTION BAG (235X350X0.03)	M6E6E7	
-	-		H25-0651-04	PROTECTION BAG	T6T7	
-	-		H25-0661-04	PROTECTION BAG	K6P6Y6	
-	-		H25-0661-04	PROTECTION BAG	T6E6	
-	-		H25-0661-04	PROTECTION BAG	7	
-	-		H50-2414-04	ITEM CARTON CASE	K7P7Y7	
-	-		H50-2415-04	ITEM CARTON CASE	T7	
-	-	*	H50-2416-04	ITEM CARTON CASE	E7	
-	-	*	H50-2417-04	ITEM CARTON CASE	K6P6Y6	
-	-	*	H50-2418-04	ITEM CARTON CASE	M6	
-	-	*	H50-2419-04	ITEM CARTON CASE	T6	
-	-	*	H50-2420-04	ITEM CARTON CASE	E6	
630	2E		J02-1151-03	FOOT		
631	2D		J21-3326-05	JACK MOUNTING HARDWARE		
Δ 633	1E		J42-0083-05	POWER CORD BUSHING		
634	1C		J90-0811-04	GUIDE		
-	-		J61-0307-05	WIRE BAND		
640	1C		K27-2178-04	KNOB (BUTTON)		
641	1D	*	K29-6681-24	KNOB ASSY		
Δ 645	1E	*	L07-2304-05	POWER TRANSFORMER	K6P6	
Δ 645	1E	*	L07-2304-05	POWER TRANSFORMER	K7P7	
Δ 645	1E	*	L07-2306-05	POWER TRANSFORMER	Y6M6Y7	
645	1E	*	L07-2411-05	POWER TRANSFORMER	T6E6	
645	1E	*	L07-2411-05	POWER TRANSFORMER	T7E7	
D-R350						
601	1F	*	A01-3440-01	METALLIC CABINET		
603	2F	*	A21-1964-03	DRESSING PANEL		
604	2F	*	A29-0858-12	PANEL		
605	2G	*	A60-1138-21	PANEL	K3P3Y3	
605	2G	*	A60-1190-21	PANEL	E3I3	
605	2G	*	A60-1190-21	PANEL	M3X3T3	
612	1G	*	B12-0313-14	INDICATOR		
610	2G	*	B10-2353-22	FRONT GLASS		
611	2G	*	B12-0312-04	INDICATOR		
-	-		B46-0096-53	WARRANTY CARD	X3	
-	-		B46-0197-00	QUESTIONNAIRE CARD	K3	
-	-		B46-0310-03	WARRANTY CARD	T3E3	
-	-		B46-0328-03	WARRANTY CARD	K3Y3	
-	-	*	B46-0336-03	WARRANTY CARD	P3	
-	-		B58-0513-04	CAUTION CARD (PRESET220-240)	Y3	
-	-		B58-0945-03	CAUTION CARD	T3	
-	-		B58-0964-13	CAUTION CARD (UL)	K3Y3	
-	-	*	B58-0965-13	CAUTION CARD (T,XtypePL)	X3T3	
-	-	*	B58-0966-13	CAUTION CARD (ELMtypepl)	M3E3I3	
-	-	*	B58-0967-03	CAUTION CARD (PtypePL)	P3	
-	-		B59-1104-00	SERVICE DIRECTORY	Y3	
-	-	*	B60-3276-00	INSTRUCTION MANUAL(ENGLISH)	I3	
-	-	*	B60-3276-00	INSTRUCTION MANUAL(ENGLISH)	K3P3Y3	
-	-	*	B60-3276-00	INSTRUCTION MANUAL(ENGLISH)	M3X3T3	

L : Scandinavia K : USA P : Canada R : Mexico
 Y : PX(Far East, Hawaii) T : Europe E : Europe G : Germany
 Y : AAFES(Europe) X : Australia M : Other Areas Q : Russia

Δ indicates safety critical components.

1060CD/1070CD/DP-R6090/R7090/D-R350
PARTS LIST

* New Parts
Parts without **Parts No.** are not supplied.
Les articles non mentionnés dans le **Parts No.** ne sont pas fournis.
Teile ohne **Parts No.** werden nicht geliefert.

3

Ref. No	Add-ress	New Parts	Parts No.	Description	Desti-nation	Re-marks
-		*	B60-3277-00	INSTRUCTION MANUAL(FRENCH)	P3E3	
-		*	B60-3278-00	INSTRUCTION MANUAL(GER,DUTCH)	E3	
-		*	B60-3279-00	INSTRUCTION MANUAL(ITAL)	E3	
-		*	B60-3280-00	INSTRUCTION MANUAL(SPANISH)	M3E3	
-		*	B60-3281-00	INSTRUCTION MANUAL(TAIWANESE)	M3I3	
615	1G,2G		D14-0357-04	ROLLER		
Δ 620	1F		E03-0115-05	AC PLUG ADAPTER	M3I3	
622	1H		E30-0505-05	AUDIO CORD		
Δ 622	1H		E30-2592-15	AC POWER CORD	M3E3I3	
Δ 622	1H		E30-2605-05	AC POWER CORD	Y3	
Δ 622	1H		E30-2650-05	AC POWER CORD	K3P3	
Δ 622	1H		E30-2717-05	AC POWER CORD	X3	
Δ 622	1H		E30-2829-05	AC POWER CORD	T3	
623	1F		E30-2733-05	CORD WITH PLUG		
625	1H	*	E35-0400-05	WIRING HARNESS		
630	2H	*	F31-0279-04	REINFORCING HARDWARE		
-		*	G11-2333-14	CUSHION		
-		*	G16-0899-04	SHEET		
-		*	H10-7294-02	POLYSTYRENE FOAMED FIXTURE	I3	
-		*	H10-7294-02	POLYSTYRENE FOAMED FIXTURE	K3P3Y3	
-		*	H10-7294-02	POLYSTYRENE FOAMED FIXTURE	M3X3E3	
-		*	H10-7295-02	POLYSTYRENE FOAMED FIXTURE	I3	
-		*	H10-7295-02	POLYSTYRENE FOAMED FIXTURE	K3P3Y3	
-		*	H10-7295-02	POLYSTYRENE FOAMED FIXTURE	M3X3E3	
-		*	H10-7296-02	POLYSTYRENE FOAMED FIXTURE	T3	
-		*	H10-7297-02	POLYSTYRENE FOAMED FIXTURE	T3	
-		*	H13-0260-04	CARTON BOARD	X3	
-		*	H20-0568-04	PROTECTION COVER	M3I3	
-		*	H21-0351-04	PROTECTION SHEET		
-		*	H25-0232-04	PROTECTION BAG (235X350X0.03)	I3	
-		*	H25-0232-04	PROTECTION BAG (235X350X0.03)	K3P3Y3	
-		*	H25-0232-04	PROTECTION BAG (235X350X0.03)	M3X3E3	
-		*	H25-0651-04	PROTECTION BAG	T3	
-		*	H25-0661-04	PROTECTION BAG	K3P3Y3	
-		*	H25-0661-04	PROTECTION BAG	X3T3E3	
-		*	H30-0602-04	ADHESIVE DOUBLE-COATED TAPE		
-		*	H50-2377-04	ITEM CARTON CASE	K3P3Y3	
-		*	H50-2377-04	ITEM CARTON CASE	X3E3	
-		*	H50-2378-04	ITEM CARTON CASE	M3I3	
-		*	H50-2379-04	ITEM CARTON CASE	T3	
632	2H		J02-1189-13	FOOT		
Δ 633	1H		J42-0083-05	POWER CORD BUSHING		
634	1G		J90-0811-04	GUIDE		
-			J61-0101-05	WIRE BAND		
-			J61-0307-05	WIRE BAND		
635	2G	*	K29-6648-12	KNOB		
636	2G	*	K29-6649-02	KNOB		
Δ 640	2H	*	L07-2304-05	POWER TRANSFORMER	K3P3	
Δ 640	2H	*	L07-2306-05	POWER TRANSFORMER	Y3M3I3	
Δ 640	2H	*	L07-2411-05	POWER TRANSFORMER	X3T3E3	

L : Scandinavia K : USA P : Canada R : Mexico
Y : PX(Far East, Hawaii) T : Europe E : Europe G : Germany
Y : AAFES(Europe) X : Australia M : Other Areas

Δ indicates safety critical components.

* New Parts
Parts without **Parts No.** are not supplied.
Les articles non mentionnés dans le **Parts No.** ne sont pas fournis.
Teile ohne **Parts No.** werden nicht geliefert.

4

Ref. No	Add-ress	New Parts	Parts No.	Description	Desti-nation	Re-marks
DISPLAY UNIT (X25-590x-xx) for 1060CD/1070CD/DP-R6090/DP-R7090						
D1-5			B30-2467-05	LED		
C1			C90-3212-05	ELECTRO	47UF	6.3WV
C2			CK45FF1H103ZMU	CERAMIC	0.010UF	Z
C3			CC45FSL1H330JM	CERAMIC	33PF	J
C4,5			CK45FF1H103ZMU	CERAMIC	0.010UF	Z
C6			CF92FV1H104J	MF-C	0.10UF	J
CN1			E40-4944-05	FLAT CABLE CONNECTOR		
-			J19-5789-04	HOLDER		
S1-5			S70-0802-05	TACT SWITCH		
S6-20			S70-0031-05	TACT SWITCH		
S21			S40-2351-05	PUSH SWITCH		
ED1			FIP15XM1BA	INDICATOR TUBE		
IC1			LC75712E	MOS-IC		
A1			W02-2537-05	ELECTRIC CIRCUIT MODULE		
DISPLAY UNIT (X25-591x-xx) for D-R350						
D1-5		*	B30-2508-05	LED(AMBER,D=3,P=2)		
D6			B30-2513-05	LED(RED)		
C1			C90-3222-05	ELECTRO	100UF	10WV
C2			CK45FF1H103ZMU	CERAMIC	0.010UF	Z
C3			CC45FSL1H330JM	CERAMIC	33PF	J
C4			CF92FV1H104J	MF-C	0.10UF	J
C5-7			CC45FSL1H470JM	CERAMIC	47PF	J
CN1			E40-4944-05	FLAT CABLE CONNECTOR		
-			J19-5789-04	HOLDER		
E5			J11-0809-05	WIRE CLAMPER		
S1-14			S70-0031-05	TACT SWITCH		
D7,8			HSS104	DIODE		
D7,8			1SS133	DIODE		
ED1			FIP15XM1BA	INDICATOR TUBE		
IC1			LC75712E	MOS-IC		
Q1			2SD1302(S,T)	TRANSISTOR		
Q2			DTA124ESA	DIGITAL TRANSISTOR		
Q2			UN4112	DIGITAL TRANSISTOR		
Q3			DTC124ESA	DIGITAL TRANSISTOR		
Q3			UN4212	DIGITAL TRANSISTOR		
CD PLAYER UNIT (X32-333x-xx)						
C1			CK73FB1H103K	CHIP C	0.010UF	K
C2			CK73FB1H473K	CHIP C	0.047UF	K
C3			CK73FB1E104K	CHIP C	0.10UF	K
C4			CC73FSL1H470J	CHIP C	47PF	J
C5			CE04KW1A101M	ELECTRO	100UF	10WV
C6-8			CK73FB1E104K	CHIP C	0.10UF	K
C9			CK73FB1H102K	CHIP C	1000PF	K
C10			CC73FSL1H221J	CHIP C	220PF	J

L : Scandinavia K : USA P : Canada R : Mexico
Y : PX(Far East, Hawaii) T : Europe E : Europe G : Germany
Y : AAFES(Europe) X : Australia M : Other Areas

Δ indicates safety critical components.

* New Parts
 Parts without **Parts No.** are not supplied.
 Les articles non mentionnés dans le **Parts No.** ne sont pas fournis.
 Teile ohne **Parts No.** werden nicht geliefert.

5

Ref. No	Add-ress	New Parts	Parts No.	Description	Desti-nation	Re-marks
C11			CK73FB1H473K	CHIP C 0.047UF K		
C12			CE04KW1C100M	ELECTRO 10UF 16WV		
C13			CK73FB1H393K	CHIP C 0.039UF K		
C14			CK73FB1H103K	CHIP C 0.010UF K		
C15			CC73FSL1H151J	CHIP C 150PF J		
C16			CE04HW1E100M	NP-ELEC 10UF 25WV		
C17			CK73FB1H103K	CHIP C 0.010UF K		
C18			CK73FB1H333K	CHIP C 0.033UF K		
C19			CE04KW1A101M	ELECTRO 100UF 10WV		
C20,21			CK73FB1H103K	CHIP C 0.010UF K		
C22			CK73FB1H333K	CHIP C 0.033UF K		
C23			CK73FB1H103K	CHIP C 0.010UF K		
C24			CK73FB1H222K	CHIP C 2200PF K		
C25			CK73FB1H103K	CHIP C 0.010UF K		
C26			CC73FSL1H680J	CHIP C 68PF J		
C27			C90-3222-05	ELECTRO 100UF 10WV		
C28			CK73FB1H223K	CHIP C 0.022UF K		
C29			CK73FB1H102K	CHIP C 1000PF K		
C30			CK73FB1H103K	CHIP C 0.010UF K		
C31			CE04KW1A101M	ELECTRO 100UF 10WV		
C32			CK73FB1E104K	CHIP C 0.10UF K		
C33			CK73FB1H473K	CHIP C 0.047UF K		
C34			CK73FB1H152K	CHIP C 1500PF K		
C35			CK73FB1H103K	CHIP C 0.010UF K		
C36			CK73FB1E104K	CHIP C 0.10UF K		
C37			CK73FB1H332K	CHIP C 3300PF K		
C38			CK73FB1H103K	CHIP C 0.010UF K		
C39			CK73FB1C224K	CHIP C 0.22UF K		
C40			CK73FB1E104K	CHIP C 0.10UF K		
C41			CE04KW1A101M	ELECTRO 100UF 10WV		
C42			CK73FB1H103K	CHIP C 0.010UF K		
C43,44			CC73FSL1H221J	CHIP C 220PF J		
C45			CK73FB1H103K	CHIP C 0.010UF K		
C46,47			CK73FB1E104K	CHIP C 0.10UF K		
C48			CE04KW1C100M	ELECTRO 10UF 16WV		
C49,50			CE04KW1A101M	ELECTRO 100UF 10WV		
C51			C90-3215-05	ELECTRO 220UF 6.3WV		
C52			CK73FB1E104K	CHIP C 0.10UF K		
C53,54			CC73FSL1H150J	CHIP C 15PF J	3/6	
C55			CK73FB1H102K	CHIP C 1000PF K	7	
C56			CK73FB1H103K	CHIP C 0.010UF K		
C57,58			C90-3216-05	ELECTRO 330UF 6.3WV		
C59,60			CC73FSL1H151J	CHIP C 150PF J	3/6	
C61			C90-3216-05	ELECTRO 330UF 6.3WV	7	
C62			CC73FSL1H470J	CHIP C 47PF J	3/6	
C63,64			CK73FB1H102K	CHIP C 1000PF K	7	
C65,66			CC73FSL1H470J	CHIP C 47PF J	7	
C67			C90-3215-05	ELECTRO 220UF 6.3WV	7	
C68-72			CK73FB1H103K	CHIP C 0.010UF K	7	
C73			CC73FSL1H330J	CHIP C 33PF J	7	
C74			CC73FSL1H560J	CHIP C 56PF J	7	
C75-78			CE04KW0J331M	ELECTRO 330UF 6.3WV	7	
C79-82			CK45FF1H103ZMU	CERAMIC 0.010UF Z	7	
C83-86			CK73FSL1H221J	CHIP C 220PF J	7	
C87-90			CC73FSL1H470J	CHIP C 47PF J	7	

L : Scandinavia K : USA P : Canada R : Mexico
 Y : PX(Far East, Hawaii) T : Europe E : Europe G : Germany
 Y : AAFES(Europe) X : Australia M : Other Areas

▲ indicates safety critical components.

* New Parts
 Parts without **Parts No.** are not supplied.
 Les articles non mentionnés dans le **Parts No.** ne sont pas fournis.
 Teile ohne **Parts No.** werden nicht geliefert.

5

Ref. No	Add-ress	New Parts	Parts No.	Description	Desti-nation	Re-marks
C91,92			CC73FSL1H471J	CHIP C 470PF J		7
C93-96			CC45FSL1H121JM	CERAMIC 120PF J		3
C93-96			CC45FSL1H820JM	CERAMIC 82PF J		6
C93-96			CQ93FMG1H512J	MYLAR 5100PF J		7
C97,98			CQ93FMG1H273J	MYLAR 0.027UF J		
C99,100			CQ93FMG1H332J	MYLAR 3300PF J		
C101,102			CE04KW1A470M	ELECTRO 47UF 10WV		
C103,104			CK73FB1H103K	CHIP C 0.010UF K		
C105,106			CK73FB1H103K	CHIP C 0.010UF K		6/7
C107,108			CC73FSL1H821J	CHIP C 820PF J		
C109,110			CE04KW1H010M	ELECTRO 1.0UF 50WV		6/7
C111,112			CE04KW1A101M	ELECTRO 100UF 10WV		6/7
C113,114			CK73FB1H102K	CHIP C 1000PF K		6/7
C116			CK73FB1H103K	CHIP C 0.010UF K		6/7
C117,118			CK73FB1H103K	CHIP C 0.010UF K		
C119,120			CK73FB1H103K	CHIP C 0.010UF K		7
C121			CE04KW0J331M	ELECTRO 330UF 6.3WV		
C125			CK73FB1H103K	CHIP C 0.010UF K		7
C126,127			CK45FF1H103ZMU	CERAMIC 0.010UF Z		
C128			CE04KW1C332M	ELECTRO 3300UF 16WV		
C129			CK73FB1H103K	CHIP C 0.010UF K		
C130			CE04KW1A331M	ELECTRO 330UF 10WV		
C131			CE04DW1E331M	ELECTRO 330UF 25WV		
C132			CE04DW1J101M	ELECTRO 100UF 63WV		
C133			CK73FB1H103K	CHIP C 0.010UF K		
C134			CE04KW1H100M	ELECTRO 10UF 50WV		
C135			CE04KW1C100M	ELECTRO 10UF 16WV		
C136-138			CK73FB1H103K	CHIP C 0.010UF K		
C141,142			CK73FB1H103K	CHIP C 0.010UF K		
C143-145			CC73FSL1H470J	CHIP C 47PF J		7
C146,147			CK73FB1H103K	CHIP C 0.010UF K		7
C148			CK73FB1H102K	CHIP C 1000PF K		3
C149			CK73FB1H103K	CHIP C 0.010UF K		7
C150			CK73FB1H103K	CHIP C 0.010UF K		7
C151			CK73FB1E104K	CHIP C 0.10UF K		
CN1			E40-8037-05	FLAT CABLE CONNECTOR		
CN2			E40-0711-05	PIN ASSY		
CN3			E40-3250-05	PIN ASSY		
CN4			E40-3252-05	PIN ASSY		
CN5			E40-4187-05	FLAT CABLE CONNECTOR		
CN6			E40-4906-05	FLAT CABLE CONNECTOR		
CN7			E40-4297-05	FLAT CABLE CONNECTOR		
CN8			E40-4245-05	PIN ASSY		3
CN9			E40-4187-05	FLAT CABLE CONNECTOR		
CN10			E40-4245-05	PIN ASSY		6/7
J1			E63-1009-05	PHONO JACK		
J2			E11-0293-05	MINIATURE PHONE JACK(2P)		
J3			E63-0199-05	PHONO JACK		
J4			E11-0127-05	PHONE JACK (3P)		6/7
E9-11			J11-0808-05	WIRE CLAMPER		
E12			J11-0809-05	WIRE CLAMPER		
E13			J11-0808-05	WIRE CLAMPER		6/7
L1			L40-1001-17	SMALL FIXED INDUCTOR(10UH,K)		

L : Scandinavia K : USA P : Canada R : Mexico
 Y : PX(Far East, Hawaii) T : Europe E : Europe G : Germany
 Y : AAFES(Europe) X : Australia M : Other Areas

▲ indicates safety critical components.

1060CD/1070CD/DP-R6090/R7090/D-R350
 PARTS LIST

* New Parts
 Parts without **Parts No.** are not supplied.
 Les articles non mentionnés dans le **Parts No.** ne sont pas fournis.
 Teile ohne **Parts No.** werden nicht geliefert.



Ref. No	Add-ress	New Parts	Parts No.	Description	Desti-nation	Re-marks
L3,4 L11,12 X1 X2 X3			L40-1091-17 L40-1001-17 L77-2217-05 L77-2217-05 L78-0284-05	SMALL FIXED INDUCTOR SMALL FIXED INDUCTOR(10UH,K) CRYSTAL RESONATOR(16.9344MHZ) CRYSTAL RESONATOR(16.9344MHZ) RESONATOR (5MHZ)	6/7 6/7 3/6 7	
R1-4 R5 R6 R7 R8			RK73FB2A683J RK73FB2A753J RK73FB2A104J RK73FB2A101J RK73FB2A103J	CHIP R 68K J 1/10W CHIP R 75K J 1/10W CHIP R 100K J 1/10W CHIP R 100 J 1/10W CHIP R 10K J 1/10W		
R9 R10 R11 R12 R13			RK73FB2A334J RK73FB2A473J RK73FB2A104J RK73FB2A242J RK73FB2A682J	CHIP R 330K J 1/10W CHIP R 47K J 1/10W CHIP R 100K J 1/10W CHIP R 2.4K J 1/10W CHIP R 6.8K J 1/10W		
R14 R16 R17 R18 R19,20			RK73FB2A101J RK73FB2A684J RK73FB2A103J RK73FB2A105J RK73FB2A114J	CHIP R 100 J 1/10W CHIP R 680K J 1/10W CHIP R 10K J 1/10W CHIP R 1.0M J 1/10W CHIP R 110K J 1/10W		
R21,22 R23 R24 R25 R26			RK73FB2A155J RK73FB2A394J RK73FB2A563J RK73FB2A103J RK73FB2A104J	CHIP R 1.5M J 1/10W CHIP R 390K J 1/10W CHIP R 56K J 1/10W CHIP R 10K J 1/10W CHIP R 100K J 1/10W		
R27 R28 R29 R30,31 R32			RK73FB2A223J RK73FB2A154J RK73FB2A752J RK73FB2A472J RK73FB2A183J	CHIP R 22K J 1/10W CHIP R 150K J 1/10W CHIP R 7.5K J 1/10W CHIP R 4.7K J 1/10W CHIP R 18K J 1/10W		
R33 R34 R35 R36 R37			RK73FB2A154J RK73FB2A103J RK73FB2A244J RK73FB2A152J RK73FB2A103J	CHIP R 150K J 1/10W CHIP R 10K J 1/10W CHIP R 240K J 1/10W CHIP R 1.5K J 1/10W CHIP R 10K J 1/10W		
R38 R39 R40 R41 R42			RK73FB2A102J RK73FB2A100J RK73FB2A224J RK73FB2A105J RK73FB2A472J	CHIP R 1.0K J 1/10W CHIP R 10 J 1/10W CHIP R 220K J 1/10W CHIP R 1.0M J 1/10W CHIP R 4.7K J 1/10W		
R43 R44 R45,46 R47 R48			RK73FB2A623J RK73FB2A912J RK73FB2A203J RK73FB2A104J RK73FB2A332J	CHIP R 62K J 1/10W CHIP R 9.1K J 1/10W CHIP R 20K J 1/10W CHIP R 100K J 1/10W CHIP R 3.3K J 1/10W		
R49 R50 R51 R52 R53-55			RK73FB2A103J RK73FB2A332J RK73FB2A105J RK73FB2A104J RK73FB2A471J	CHIP R 10K J 1/10W CHIP R 3.3K J 1/10W CHIP R 1.0M J 1/10W CHIP R 100K J 1/10W CHIP R 470 J 1/10W		
R56 R57 R58			RK73FB2A221J RK73FB2A131J RK73FB2A220J	CHIP R 220 J 1/10W CHIP R 130 J 1/10W CHIP R 22 J 1/10W		

L : Scandinavia K : USA P : Canada R : Mexico
 Y : PX(Far East, Hawaii) T : Europe E : Europe G : Germany
 Y : AAFES(Europe) X : Australia M : Other Areas

⚠ indicates safety critical components.

* New Parts
 Parts without **Parts No.** are not supplied.
 Les articles non mentionnés dans le **Parts No.** ne sont pas fournis.
 Teile ohne **Parts No.** werden nicht geliefert.



Ref. No	Add-ress	New Parts	Parts No.	Description	Desti-nation	Re-marks
R59 R60-67 R68			RK73FB2A750J RK73FB2A471J RK73FB2A473J	CHIP R 75 J 1/10W CHIP R 470 J 1/10W CHIP R 47K J 1/10W		
R69,70 R71 R72 R73-75 R76			RK73FB2A472J RK73FB2A473J RK73FB2A471J RK73FB2A473J RK73FB2A103J	CHIP R 4.7K J 1/10W CHIP R 47K J 1/10W CHIP R 470 J 1/10W CHIP R 47K J 1/10W CHIP R 10K J 1/10W		
R77 R78 R79 R80 R81			RK73FB2A752J RK73FB2A682J RK73FB2A473J RK73FB2A473J RK73FB2A473J	CHIP R 7.5K J 1/10W CHIP R 6.8K J 1/10W CHIP R 47K J 1/10W CHIP R 47K J 1/10W CHIP R 47K J 1/10W		6/7 3/7
R83,84 R85-88 R89 R90,91 R92			RK73FB2A331J RK73FB2A104J RK73FB2A103J RK73FB2A181J RK73FB2A103J	CHIP R 330 J 1/10W CHIP R 100K J 1/10W CHIP R 10K J 1/10W CHIP R 180 J 1/10W CHIP R 10K J 1/10W		
R93 R94 R95-102 R103,104 R105,106			RK73FB2A105J RK73FB2A221J RK73FB2A103J RK73FB2A392J RK73FB2A102J	CHIP R 1.0M J 1/10W CHIP R 220 J 1/10W CHIP R 10K J 1/10W CHIP R 3.9K J 1/10W CHIP R 1.0K J 1/10W		3/6 3/6 7
R107-110 R111 R112,113 R114 R115			RK73FB2A101J RK73FB2A101J RK73FB2A471J RK73FB2A180J RK73FB2A105J	CHIP R 100 J 1/10W CHIP R 100 J 1/10W CHIP R 470 J 1/10W CHIP R 18 J 1/10W CHIP R 1.0M J 1/10W		7 7 7 7 7
R117 R118 R119-126 R127-134 R135-138			RK73FB2A220J RK73FB2A510J RK73FB2A331J R92-1858-05 RK73FB2A332J	CHIP R 22 J 1/10W CHIP R 51 J 1/10W CHIP R 330 J 1/10W CHIP R 3.6K F 1/10W CHIP R 3.3K J 1/10W		6/7 6/7 7 7 7
R139-142 R143-146 R147 R147-150 R147-150			RK73FB2A333J RK73FB2A152J RK73FB2A471J RK73FB2A243J RK73FB2A393J	CHIP R 33K J 1/10W CHIP R 1.5K J 1/10W CHIP R 470 J 1/10W CHIP R 24K J 1/10W CHIP R 39K J 1/10W		7 7 7 3 6
R151-156 R157,158 R159,160 R161 R161			RK73FB2A471J RK73FB2A104J RK73FB2A101J RS14KB3D470J RS14KB3D560J	CHIP R 470 J 1/10W CHIP R 100K J 1/10W CHIP R 100 J 1/10W FL-PROOF RS 47 J 2W FL-PROOF RS 56 J 2W		3/6 7
R163,164 R165,166 R167,168 R169,170 R171,172			RK73FB2A472J RK73FB2A102J RK73FB2A101J RK73FB2A104J RK73FB2A510J	CHIP R 4.7K J 1/10W CHIP R 1.0K J 1/10W CHIP R 100 J 1/10W CHIP R 100K J 1/10W CHIP R 51 J 1/10W		6/7 6/7
R173,174 R176-178 R179 R180 R181			RK73FB2A102J RS14KB3D560J RK73FB2A331J RK73FB2A472J RK73FB2A103J	CHIP R 1.0K J 1/10W FL-PROOF RS 56 J 2W CHIP R 330 J 1/10W CHIP R 4.7K J 1/10W CHIP R 10K J 1/10W		6/7 7

L : Scandinavia K : USA P : Canada R : Mexico
 Y : PX(Far East, Hawaii) T : Europe E : Europe G : Germany
 Y : AAFES(Europe) X : Australia M : Other Areas

⚠ indicates safety critical components.

1060CD/1070CD/DP-R6090/R7090/D-R350
PARTS LIST

* New Parts
Parts without **Parts No.** are not supplied.
Les articles non mentionnés dans le **Parts No.** ne sont pas fournis.
Teile ohne **Parts No.** werden nicht geliefert.

9

Ref. No	Add-ress	New Parts	Parts No.	Description	Desti-nation	Re-marks
R182,183			RK73FB2A101J	CHIP R 100 J 1/10W		
R184			RK73FB2A103J	CHIP R 10K J 1/10W		
R185,186			RD14NB2E1R0J	RD 1 J 1/4W		
R187,188			RK73FB2A152J	CHIP R 1.5K J 1/10W		
R189,190			RK73FB2A912J	CHIP R 9.1K J 1/10W		
R191			RK73FB2A101J	CHIP R 100 J 1/10W		
R192			RK73FB2A151J	CHIP R 150 J 1/10W	7	
R193			RK73FB2A221J	CHIP R 220 J 1/10W		
R194			RK73FB2A471J	CHIP R 470 J 1/10W	7	
R195,196			RK73FB2A220J	CHIP R 22 J 1/10W	3/6	
R195,196			RK73FB2A510J	CHIP R 51 J 1/10W	7	
R197,198			RK73FB2A101J	CHIP R 100 J 1/10W		
R199,200			RK73FB2A102J	CHIP R 1.0K J 1/10W		
R201,202			RK73FB2A621J	CHIP R 620 J 1/10W	7	
R203,204			RK73FB2A100J	CHIP R 10 J 1/10W	6/7	
R205,206			RK73FB2A102J	CHIP R 1.0K J 1/10W	6/7	
R207,208			RK73FB2A102J	CHIP R 1.0K J 1/10W	7	
R209-213			RK73FB2A102J	CHIP R 1.0K J 1/10W		
R214			RK73FB2A102J	CHIP R 1.0K J 1/10W	7	
VR1			R12-3687-05	TRIMMING POT.(33K)		
VR2			R12-3688-05	TRIMMING POT.(47K)		
VR3			R12-3687-05	TRIMMING POT.(33K)		
S1			S31-2132-05	SLIDE SWITCH	6/7	
S2			S31-2131-05	SLIDE SWITCH (POWER TYPE)	Y3M3	
S3			S31-2131-05	SLIDE SWITCH (POWER TYPE)	Y6M6Y7	
PH1			T95-0145-05	OPTO ISOLATOR		
D1-14			HSS104A	DIODE		
D1-14			1SS131	DIODE		
D21			D3SBA20F03	DIODE		
D21			RBV-402LFA	DIODE		
D22,23			S5688B	DIODE		
D22,23			1SR139-400	DIODE		
D24			MTZJ10(B)	ZENER DIODE		
D24			UZ-10BSB	ZENER DIODE		
D25,26			MTZJ20(B)	ZENER DIODE		
D25,26			UZ-20BS	ZENER DIODE		
D27			MTZJ15(B)	ZENER DIODE		
D27			UZ-15BSB	ZENER DIODE		
D28-30			S5688B	DIODE		
D28-30			1SR139-400	DIODE		
D31			SIR-33ST3	INFRARED LED		
IC1			CXA1782BQ*1	ANALOGUE IC		
IC2			CXD2507AQ*1	MOS-IC		
IC3		*	UPD78055GC-A03	MI-COM IC		
IC4			W24257S-70LL	MEMORY IC		
IC5			TC74HC373AF	IC(8 bit LATCH)		
IC6			LC89170M	MOS-IC		
IC7			KAN03	CUSTOM IC		
IC8			ICP-N25	ANALOGUE IC		
IC11			KAN05	CUSTOM IC	7	
IC12		*	TC74VHC04F	MOS-IC	7	
IC13-16		*	TC74VHC74FE	MOS-IC	7	
IC17,18			NJM4565M	IC(OP AMP X2)	7	

L : Scandinavia K : USA P : Canada R : Mexico
Y : PX(Far East, Hawaii) T : Europe E : Europe G : Germany
Y : AAFES(Europe) X : Australia M : Other Areas

⚠ indicates safety critical components.

* New Parts
Parts without **Parts No.** are not supplied.
Les articles non mentionnés dans le **Parts No.** ne sont pas fournis.
Teile ohne **Parts No.** werden nicht geliefert.

10

Ref. No	Add-ress	New Parts	Parts No.	Description	Desti-nation	Re-marks
IC19,20			NJM4565M	IC(OP AMP X2)		
IC21			NJM4580E	ANALOGUE IC	6/7	
IC22			BA5936S	ANALOGUE IC		
IC23			PST993D-T	ANALOGUE IC		
IC24			ICP-N10	ANALOGUE IC		
PH2			RPT-38PT3F	PHOTO TRANSISTOR		
Q1			2SC1740S(Q,R)	TRANSISTOR		
Q1			2SC2785(F,E)	TRANSISTOR		
Q2			2SA954(L,K)	TRANSISTOR		
Q3,4			DTA124ESA	DIGITAL TRANSISTOR		
Q3,4			UN4112	DIGITAL TRANSISTOR		
Q5-9			DTC113ZSA	DIGITAL TRANSISTOR		
Q5-9			UN4219	DIGITAL TRANSISTOR		
Q10,11			DTC124ESA	DIGITAL TRANSISTOR		
Q10,11			UN4212	DIGITAL TRANSISTOR		
Q12			DTC113ZSA	DIGITAL TRANSISTOR	3	
Q12			UN4219	DIGITAL TRANSISTOR	3	
Q13,14			DTA124ESA	DIGITAL TRANSISTOR		
Q13,14			UN4112	DIGITAL TRANSISTOR		
Q15,16			DTC124ESA	DIGITAL TRANSISTOR		
Q15,16			UN4212	DIGITAL TRANSISTOR		
Q17,18			2SC2878(B)	TRANSISTOR		
Q19			2SB1370	TRANSISTOR		
Q19			2SB1375	TRANSISTOR		
Q20,21			2SD2012	TRANSISTOR	3/6	
Q20,21			2SD2061	TRANSISTOR	3/6	
Q20,21			2SD2396(J,K)	TRANSISTOR	7	
Q22			2SA954(L,K)	TRANSISTOR		
Q23			2SC1740S(Q,R)	TRANSISTOR		
Q23			2SC2785(F,E)	TRANSISTOR		
Q24			2SA1175(F,E)	TRANSISTOR		
Q24			2SA933AS(Q,R)	TRANSISTOR		
Q25,26			2SC2878(B)	TRANSISTOR		
Q27,28			2SC2878(B)	TRANSISTOR	6/7	
Q29,30			DTC124ESA	DIGITAL TRANSISTOR	7	
Q29,30			UN4212	DIGITAL TRANSISTOR	7	
Q31			DTA113ZSA	DIGITAL TRANSISTOR	7	
Q31			UN4119	DIGITAL TRANSISTOR	7	
A1			W02-1114-05	OSCILLATING MODULE		
CD MECHANISM (X92-193x-xx) CDM-25						
1	3B	*	A10-3121-42	CHASSIS ASSY		
2	1A	*	A11-1048-12	SUB CHASSIS		
3	1A	*	A11-1017-22	SUB CHASSIS		
5	2B	*	B09-0250-04	CAP		
7	2A	*	D10-3439-13	ARM		
8	2B	*	D10-3438-12	SLIDER		
9	1A	*	D13-1577-14	GEAR		
10	2A	*	D13-1578-04	GEAR		
11	2A	*	D13-1579-04	GEAR		
12	3D	*	D13-1682-04	WORM		
13	2C	*	D13-1581-04	GEAR		
14	2C,2E	*	D14-0357-04	ROLLER		
16	3A	*	D15-0359-04	PULLEY		

L : Scandinavia K : USA P : Canada R : Mexico
Y : PX(Far East, Hawaii) T : Europe E : Europe G : Germany
Y : AAFES(Europe) X : Australia M : Other Areas

⚠ indicates safety critical components.

1060CD/1070CD/DP-R6090/R7090/D-R350
PARTS LIST

* New Parts
 Parts without **Parts No.** are not supplied.
 Les articles non mentionnés dans le **Parts No.** ne sont pas fournis.
 Teile ohne **Parts No.** werden nicht geliefert.



Ref. No	Add-ress	New Parts	Parts No.	Description	Desti-nation	Re-marks
17	1A	*	D16-0355-03	BELT		
18	2A	*	D21-1763-14	SHAFT		
19	2B		D10-3659-04	ROD		
20	1B		D13-1765-03	GEAR		
21	1B		D13-1763-04	GEAR		
25	3D	*	E35-0747-25	FLAT CABLE		
26	1B	*	E35-1317-05	FLAT CABLE		
27	2B		E40-3264-05	PIN ASSY		
29	2B	*	E35-1669-05	WIRING HARNESS		
35	2C	*	G01-3630-14	COMPRESSION SPRING		
36	2B	*	G01-3753-04	COMPRESSION SPRING		
37	2B	*	G01-3754-04	COMPRESSION SPRING		
38	3A	*	G02-1049-04	FLAT SPRING		
39	3D	*	G09-0634-04	WIRE SPRING		
41	2D	*	G02-1065-04	FLAT SPRING		
43	2B	*	J02-1121-04	INSULATOR		
44	1A	*	J11-0198-13	CLAMPER		
45	3D	*	J19-3634-04	HOLDER		
46	2A	*	J90-0811-04	GUIDE		
47	2E	*	J90-0810-32	GUIDE	6/7	
47	2E	*	J90-0834-02	GUIDE	3	
48	3C	*	J99-0575-01	TRAY	3	
48	3C	*	J99-0579-01	TRAY	6/7	
49	2C	*	J99-0547-01	TRAY		
51	1B		J90-0844-03	GUIDE		
55	2A,3A		S33-2061-05	LEVER SWITCH		
56	2B		S74-0065-05	LEAF SWITCH		
63	1A		T50-1055-04	YOKE		
64	1A	*	T99-0544-15	MAGNET		
DM	2B		A11-1114-08	DISC MOTOR ASSY		
FM	2B		T42-0872-08	FEED MOTOR ASSY		
LM	3A		T42-0524-05	DC MOTOR		
PU	1B		T25-0050-05	PICK UP		
RM	3D		T42-0670-15	DC MOTOR	3	
RM	3D	*	T42-0828-05	DC MOTOR	6/7	

L : Scandinavia K : USA P : Canada R : Mexico
 Y : PX(Far East, Hawaii) T : Europe E : Europe G : Germany
 Y : AAFES(Europe) X : Australia M : Other Areas

⚠ indicates safety critical components.

The method that parts list (Description) is read.

The model and Description that you repair by the following table are able to judge.

Model name	Description								
	Common	K	P	Y	M	X	T	E	I
1060CD	6	K6	P6	Y6	-	-	-	-	-
DP-R6090		-	-	-	M6	-	T6	E6	-
1070CD	7	K7	P7	Y7	-	-	-	-	-
DP-R7090		-	-	-	-	-	T7	E7	-
D-R350	3	K3	P3	Y3	M3	X3	T3	E3	I3

1060CD is the model name to sell in North America and Milli tally of DPR6090

1070CD is the model name to sell in North America and Milli tally of DPR7090

PARTS LIST

1060CD/1070CD/DP-R6090/R7090/D-R350

1060CD/1070CD/DP-R6090/R7090/D-R350

SPECIFICATIONS

DP-R7090

[Format]

SystemCompact disc digital audio system
LaserSemiconductor laser

[D/A Convertors]

D/A Conversion1 Bit (24 Bit Fine D.R.I.V.E.)
Oversampling32 fs (1411.2 kHz)

[Audio]

Frequency response4Hz ~ 20 kHz, ± 0.5 dB
Signal to noise ratioMore than 110 dB
Dynamic rangeMore than 100 dB
Total harmonic distortion + noise
.....Less than 0.003 % (at 1 kHz)
Channel separationMore than 100 dB (at 1 kHz)
Wow & flutter Unmeasurable Limit
Output level / impedance
Variable(Max.) 2 V / 0.8 k Ω
Digital output
Coaxial0.5 V p-p / 75 Ω
Optical-15 dBm ~ -21 dBm
(Wave length 660 nm)
Headphone output (Max.)20 mW (32 Ω)

[General]

Power consumption14 W
DimensionsW : 440 mm (17-5/16")
.....H : 125 mm (4-15/16")
.....D : 397 mm (15-5/8")
Weight (Net)5.0 kg (11.0 lb)

DP-R6090

[Format]

SystemCompact disc digital audio system
LaserSemiconductor laser

[D/A Convertors]

D/A Conversion1 Bit (D.R.I.V.E.)
Oversampling8 fs (352 kHz)

[Audio]

Frequency response4Hz ~ 20 kHz, ± 0.5 dB
Signal to noise ratioMore than 100 dB
Dynamic rangeMore than 95 dB
Total harmonic distortion + noise
.....Less than 0.005 % (at 1 kHz)
Channel separationMore than 95 dB (at 1 kHz)
Wow & flutter Unmeasurable Limit
Output level / impedance
Variable(Max.) 2 V / 0.8 k Ω
Digital output
Coaxial0.5 V p-p / 75 Ω
Optical-15 dBm ~ -21 dBm
(Wave length 660 nm)
Headphone output (Max.)20 mW (32 Ω)

[General]

Power consumption14 W
DimensionsW : 440 mm (17-5/16")
.....H : 125 mm (4-15/16")
.....D : 397 mm (15-5/8")
Weight (Net)5.0 kg (11.0 lb)

1060CD/1070CD/DP-R6090/R7090/D-R350

SPECIFICATIONS

D-R350

[Format]

SystemCompact disc digital audio system
LaserSemiconductor laser

[D/A Convertors]

D/A Conversion1 Bit. (D.R.I.V.E.)
Oversampling8 fs (352.8 kHz)

[Audio]

Frequency response4 Hz ~ 20 kHz, \pm 0.5 dB
Signal to noise ratio.....More than 100 dB
Dynamic rangeMore than 93 dB
Total harmonic distortion + noise
.....Less than 0.005 % (at 1 kHz)
Channel separationMore than 93 dB (at 1 kHz)
Wow & flutter Unmeasurable Limit
Output level / impedance
Variable1.2 V / 0.68 k Ω
Digital output
Coaxial0.5 V p-p / 75 Ω
Optical-15 dBm ~ -21 dBm
(Wave length 660 nm)

[General]

Power consumption14 W
Dimensions.....W : 400 mm (15-3/4")
H : 139 mm (5-1/2")
D : 429 mm (16-7/8")
Weight (Net).....5.3 kg (11.7 lb)

Note:

KENWOOD follows a policy of continuous advancements in development. For this reason specifications may be changed without notice.

Note:

Component and circuit are subject to modification to insure best operation under differing local conditions. This manual is based on Europe (E) standard, and provides information on regional circuit modification through use of alternate schematic diagrams, and information on regional component variations through use of parts list.

KENWOOD CORPORATION

14-6,Dogenzaka 1-chome, Shibuya-ku, Tokyo, 150 Japan

KENWOOD SERVICE CORPORATION

P.O BOX 22745, 2201 East Dominguez St., Long Beach, CA 90801-5745, U.S.A.

KENWOOD ELECTRONICS CANADA INC.

6070 Kestrel Road, Mississauga, Ontario, Canada L5T 1S8

KENWOOD ELECTRONICS LATIN AMERICA S.A.

P.O BOX 55-2791, Piso 6 plaza Chase, Cl. 47 y Aquilino de la Guardia Panama, Republic de Panama

KENWOOD ELECTRONICS U.K. LIMITED

KENWOOD House, Dwight Road, Watford, Herts., WD1 8EB., United Kingdom

KENWOOD ELECTRONICS BENELUX N.V.

Meachelsesteenweg 418, B-1930 Zaventem, Belgium

KENWOOD ELECTRONICS DEUTSCHLAND GMBH

Rembrücker Str. 15, 63150 Heusenstamm, Germany

KENWOOD ELECTRONICS FRANCE S.A.

13 Boulevard Ney, 75018 Paris, France

KENWOOD ELECTRONICS ITALIA S.p.A.

Via G. Sirtori, 7/9 20129, Milano, Italy

KENWOOD IBÉRICA S.A.

Bolivia, 239-08020 Barcelona, Spain

KENWOOD ELECTRONICS AUSTRALIA PTY. LTD.

(A.C.N. 001499 074)

P.O Box 504, 8 Figtree Drive, Australia Centre, Homebush, N.S.W. 2140, Australia

KENWOOD & LEE ELECTRONICS, LTD.

Unit 3712-3724, Level 37, Tower 1, Metroplaza, 223 Hing Fong Road, Kwai Fong N.T., Hong Kong

KENWOOD ELECTRONICS GULF FZE

P.O.Box 61318, Jebel Ali, Dubai, U.A.E.

KENWOOD ELECTRONICS SINGAPORE PTE LTD.

No. 1 Genting Lane #02-02, KENWOOD Building, Singapore, 349544

KENWOOD ELECTRONICS (MALAYSIA) SDN BHD.

#4.01 Level 4, Wisma Academy Lot 4A, Jalan 19/1 46300 Petaling Jaya Selangor Darul Ehsan Malaysia